

# USM Haller

The USM Haller system provides a wide variety of elements in standard sizes. Widths, depths and heights are indicated below. All measurements refer to the distance between axes.

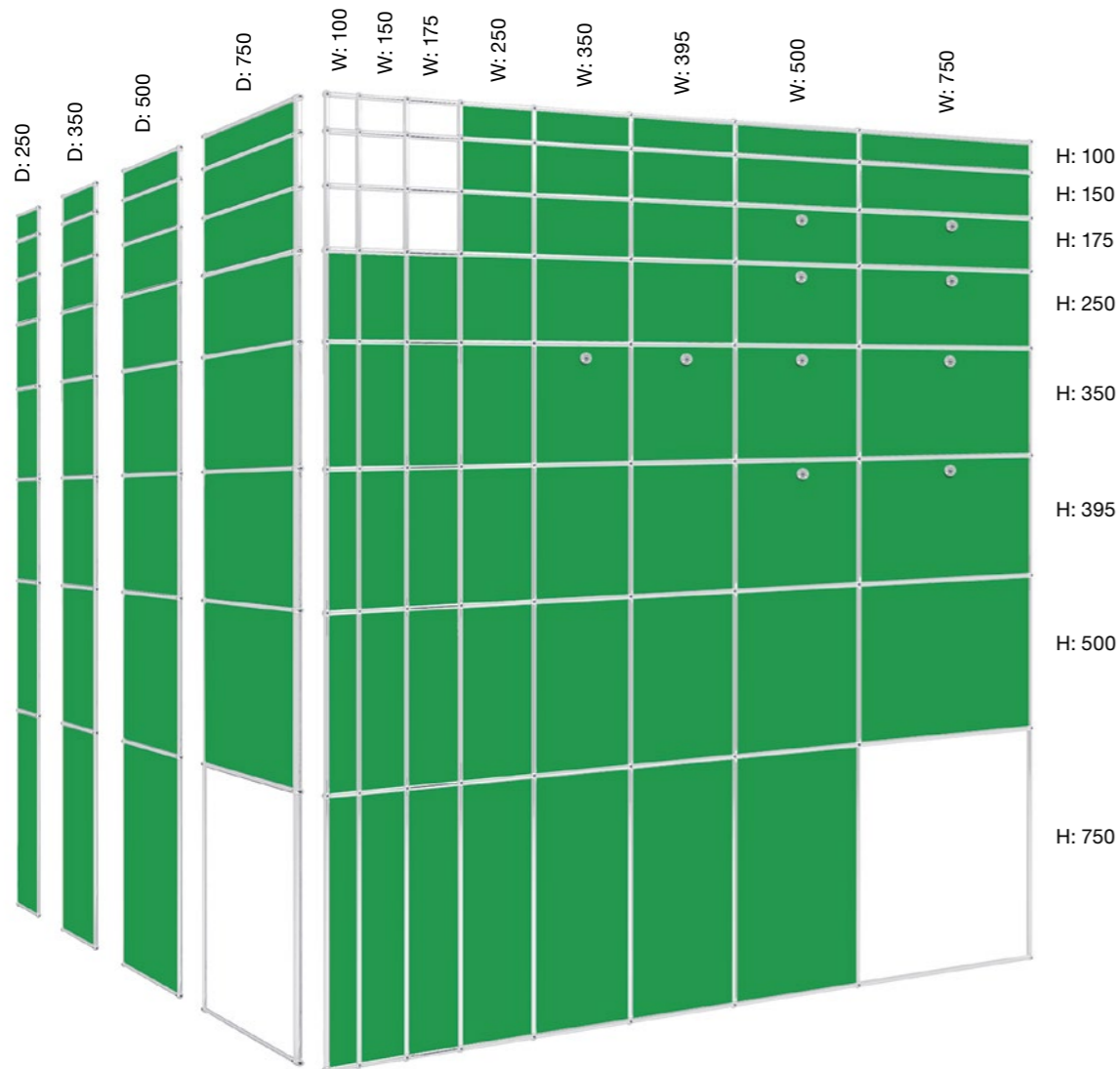

Your safety matters to us. Check out the USM safety instructions now. [www.usm.com/safety](http://www.usm.com/safety)

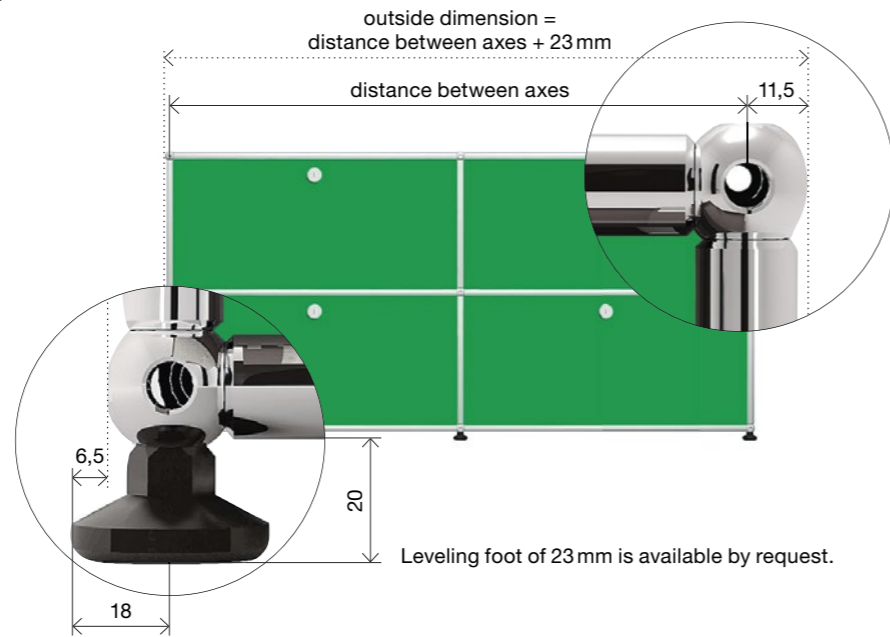

All measurements in mm.

- | Panels                   | Doors                     | Shelves and drawers  | Accessories                             |
|--------------------------|---------------------------|--|---|
| 1 Metal panel            | 5 Metal flip-up door*     | 10 Metal divider shelf                                       | 20 Hanging file baskets                 |
| 2 Glass panel            | 6 Glass door              | 11 Glass divider shelf                                       | 21 Metal box insert                     |
| 3 Acoustic panel         | 7 Acoustic drop-down door | 12 Metal extension shelf                                     | 21a Slide profile for metal box insert  |
| 4 Perforated metal panel | 8 Metal drop-down door    | 13 Metal angled shelf  | 22 Cable cut-out                        |
|                          | 9 Metal extension door*   | 14 Extension filing set with extension shelf                 | 23 Metal magnetic bookend               |
|                          |                           | 15 Small drawer D: 500                                       | 24 USM Inos box                         |
|                          |                           | 16 A6 drawer D: 500  | 25 USM Inos DVD tray                    |
|                          |                           | 17 A5 drawer D: 500  | 26 USM Inos CD tray                     |
|                          |                           | 18 A4 drawer D: 500  | 27 USM Inos angled file trays           |
|                          |                           | 19 Metal plant panel with circular recesses to hold the pots | 28 Bookend for bookshelf panel (D: 350) |
|                          |                           |  | 29 USM Inos, drawer set, open           |
|                          |                           |  | 30 USM Inos, drawer set, closed         |
|                          |                           |  | 31 USM Inos drawer organiser set        |

Start configuring your individual piece of USM now! [www.usm.com](http://www.usm.com)



Illustration: USM Haller in D: 500mm.

\*Acoustic version available. All measurements in mm.

# Colours & surfaces

## USM Haller



### Metal

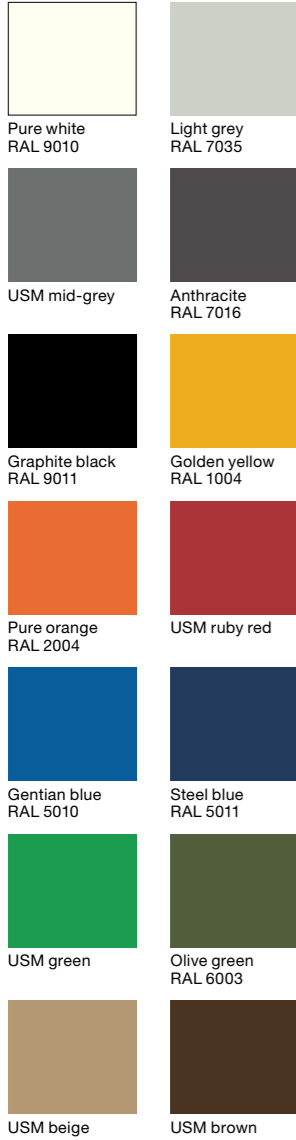

## USM Haller and USM Kitos tables



### Laminate

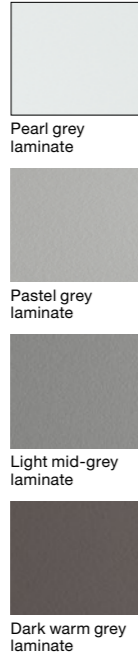

### Powder-coated MDF



### Linoleum

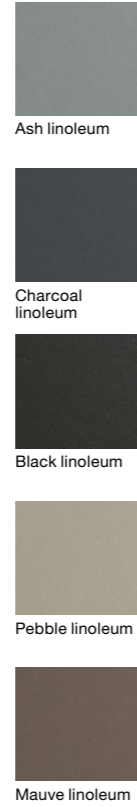

### Fenix



### Oiled or lacquered veneer

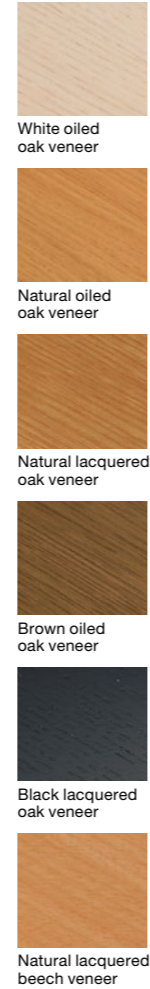

### Trans-parent glass

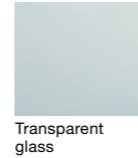

## USM Privacy Panels



### Fabric panel

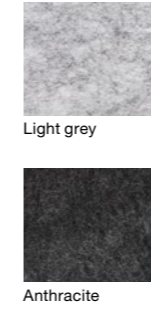

## USM Inos box



### Fabric panel

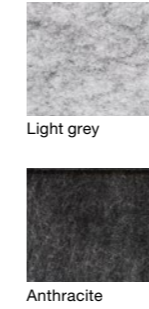

## USM Inos drawer set



### Metal

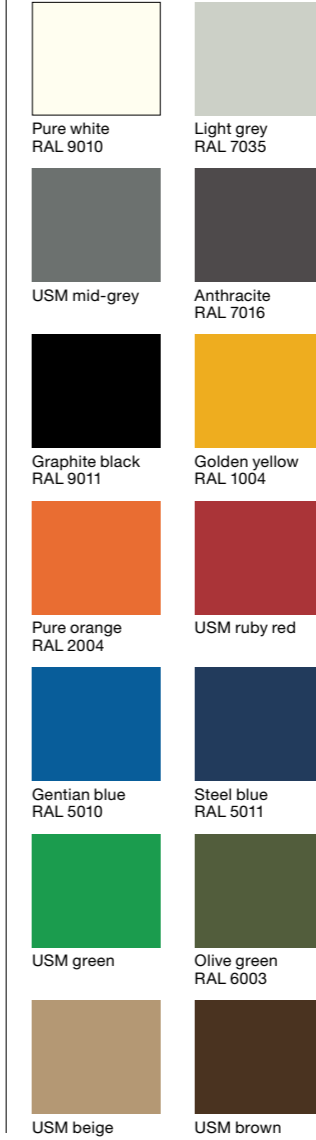

## Pots



### Clay

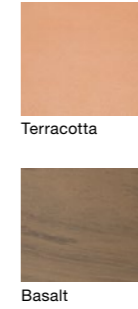

## Details

### USM Haller



Metal

### USM Haller table

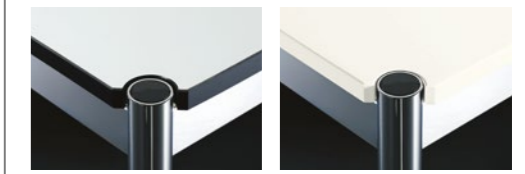

Laminate

Powder-coated MDF

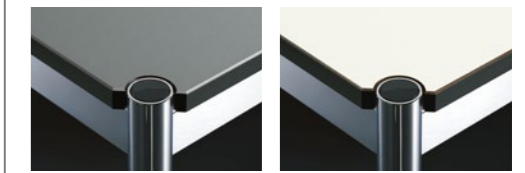

Linoleum

Fenix

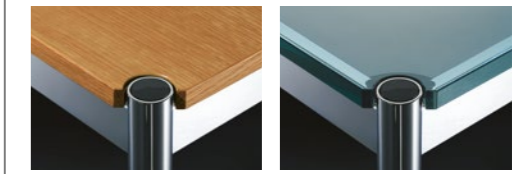

Oiled or lacquered veneer

Transparent glass

### USM Kitos table

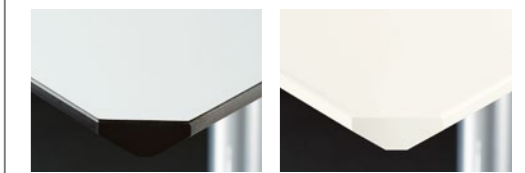

Laminate

Powder-coated MDF

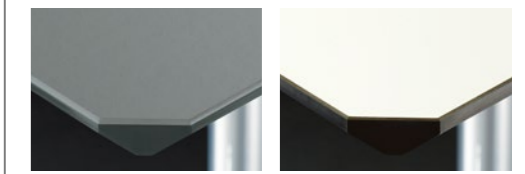

Linoleum

Fenix

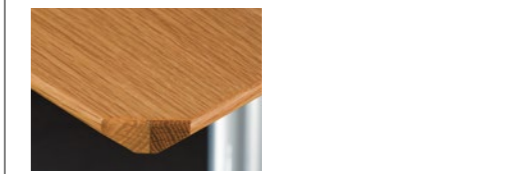

Oiled or lacquered veneer

The tabletop in glass is only available for USM Haller desks up to L: 2000 mm.  
Other colours and surfaces available upon request.  
Prices and delivery times of table surfaces upon request.

The following options are available  
in graphite black and pure white only:  
USM Inos drawer set, 5 drawers, open  
USM Inos drawer set, 10 drawers, closed  
USM Inos drawer set, 10 drawers, open