



*Modular
furniture*

Future-proof

Home Work Beyond

*Playful
by
design*

Space for your ideas

The USM universe

Origin
Sustainability
Values

Home Work *Playful by design* Beyond

Technical details

USM Haller
USM Haller Tables
USM Kitos Tables
USM Privacy Panels
USM Accessories
Colours & surfaces

Index

4
6
8

12

98

168

186

194

198

204

208

210

212



Online Configurator

Design your individual piece of USM and order online or at one of our sales partners.

[usm.com](https://www.usm.com)



Customised Service

Visit a USM Showroom or one of our 900 international sales partners worldwide for individual support.

Find your closest USM professional online.

[usm.com](https://www.usm.com)



Price list

Scan the QR code to go to the price list.



The USM universe



USM Haller is the epitome of timeless design: 60 years ago, Fritz Haller and Paul Schärer created a completely new aesthetic – a furniture system inspired by architecture.

Two visionaries, one idea

After completing his engineer studies, Paul Schärer Jr. joined the family business in 1961. The engineer had big ideas: he wanted to build a modern, industrial factory. He partnered with Fritz Haller, a respected architect of Solothurn school.

Born from architecture

Fritz Haller developed a flexible construction system with various steel modules. This inspired Paul Schärer Jr., who had a bigger vision: interior design that complements architecture. Together, they developed a modular piece of furniture that was predestined for further development.

Furniture with a system

The centrepiece of the system is a chrome-plated ball with six threaded holes. It connects the chrome-plated steel tubes in any combination. Finally, add sheet steel panels, which are powder-coated in various colours. Everything was intended for the company's own offices.

From prototype to USM Haller

When photos of the forward-thinking furniture system with its innovative aesthetics appeared in architecture journals, it was hailed an international sensation. A commission came from the Rothschild bank in Paris consisting of 600 workstations – the company's first major project. Series production began in 1969.

Less is more

With endless possibilities, the USM Haller system can be configured at will and adjusted to changing requirements, in all directions. Its strikingly fascinating minimalism is eye-catching and inspiring for everyone who values design, quality and functionality.

Modern art

An icon of modern design, USM Haller has been on display at the MoMA in New York since 2001 and recognised as a 'work of applied art' since 1988. USM Haller continues to evolve, while remaining true to itself by retaining original characteristics and invites users to challenge their own creativity.

From Münsingen out into the world

Alexander Schärer has headed up this fourth-generation family business since 2000. Production is still carried out at the headquarters in Münsingen. USM employs 500 people and currently has subsidiaries in the USA, France, Germany, UK, Japan and China. USM products are distributed by dealers in over 70 countries. Sustainability has always been a top priority. In 2008, USM was awarded Greenguard environmental certification and received the Cradle-to-Cradle® environmental label in 2018. The vision is to become a fully circular company by 2030.

4

5

Origin

1

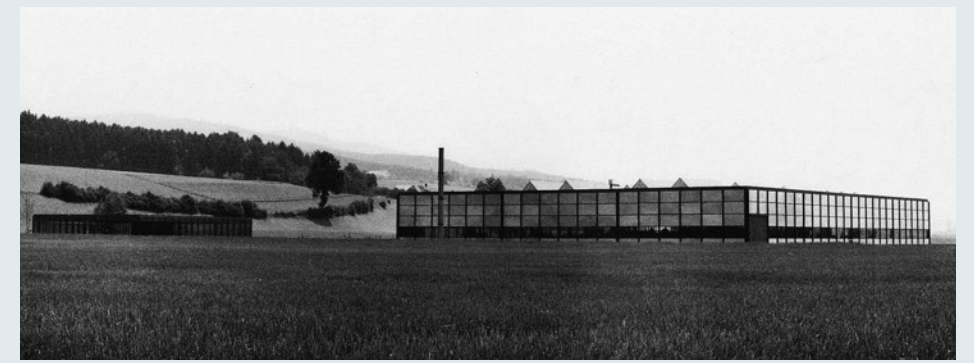

2



3



4



- 1 New factory (1963) and office pavilion (1965) in Münsingen, designed by Fritz Haller.
- 2 In 1965, USM Haller was developed to furnish personal use workspaces within visionary architecture.
- 3 Schärer family home (1969), designed by Fritz Haller, furnished with USM Haller.
- 4 The key to space. Balls, tubes, panels: what began 60 years ago continues to inspire today.

The modular icon by
Fritz Haller & Paul Schärer,
Switzerland

f. haller paul schärer

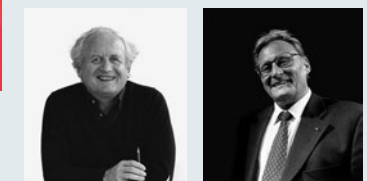

Rethink, redesign, revalue sums up the sustainable benefit of our products. USM furniture is a valuable companion for life, across generations.

What and how much do you really need? What purposes should a piece of furniture serve?

Experienced consultants and virtual planning tools enable us to support you to create a bespoke and conscious purchase. So that you get exactly what you really need, tailored to your current requirements. But don't worry, once furniture has been designed, it can always be rethought and adapted to new circumstances.

re
think

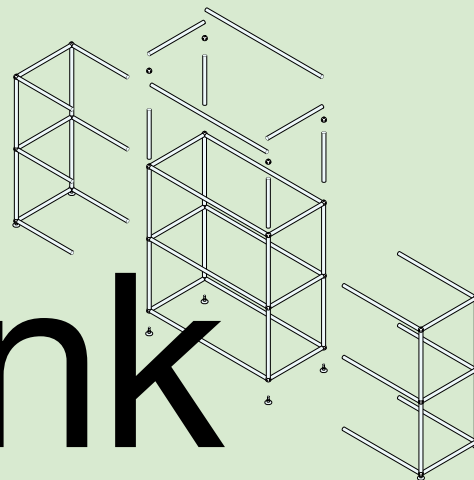

Each piece is unique, planned and assembled especially for you. Our furniture is designed to be forever reconfigured.

Thanks to the high-quality finish and clever design, all components can be changed and extended at any time without any problems. This leads to limitless creative freedom, more individuality in design and almost infinite cycles of use.

re
design

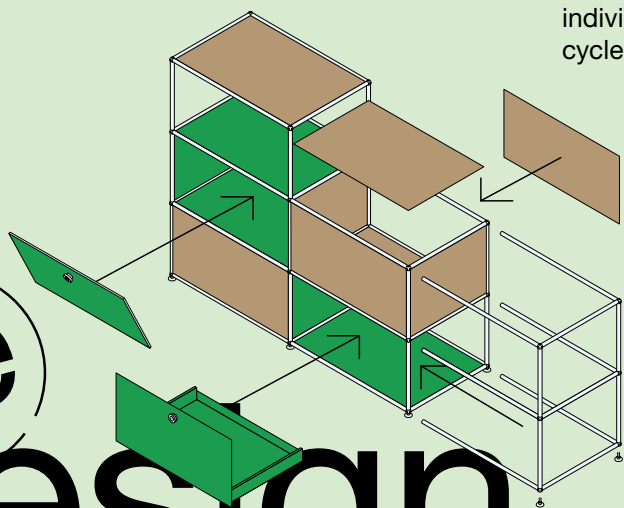

Sustainability

Thanks to the high quality, colours that never fade and a 100% modular system, decades-old USM furniture can be seamlessly combined and upgraded with new components. We believe a product that adapts to your style, your life, your changing needs is relevant and loved.

re
value

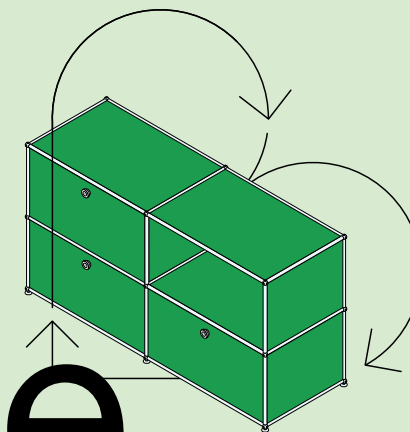

Our vision:
Becoming a fully circular business

We want to extend circularity principles beyond our products. That means adopting this philosophy throughout our company – from our product development to our manufacturing, and new business models, from our communications to our supply chain, operations and the expertise of our people.

USM furniture is a valuable companion for life, across generations.



Our product lines USM Haller and USM Kitos M, accounting for more than 92% of our revenue, carry the Cradle-to-Cradle® certification. It is the leading multi-attribute standard used globally across industries for designing and making products that enable a healthy, fair and sustainable future according to the world's most advanced science-based measures.



All four of our main product lines carry the UL Greenguard Certification for low chemical emission. Having undergone rigorous scientific testing to meet stringent emissions requirements, this certification confirms that our products contribute to a healthier indoor air quality.

Learn more at www.usm.com/sustainability



Building future-proof possibilities:
Our core values run deep and permeate
every element of what we do – from
building furniture to building relationships.



Timeless Aesthetic

Invented by architect and industrial visionary Fritz Haller at the beginning of the 1960s, the USM Haller System is characterised by a globally recognised, timeless design that compliments buildings' architecture.



Evolving Design

USM furniture isn't static; it can be reconfigured to follow the evolution of users' needs, even after many years. Whether there are changes in use or size, new components will always be compatible with older USM Haller system products.

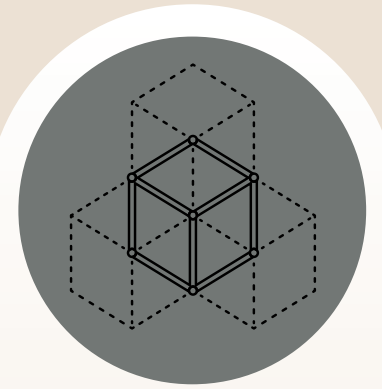

Coherence of Furniture

Thanks to its unique modular design, the USM system can meet all furniture needs.



Strength and Durability

Produced with the same high quality since its invention 60 years ago, the USM Haller system relies on a unique structural system composed of chromed tubes joined by connecting balls and thermo-lacquered panels, resulting in remarkable durability and timeless style.



Small Footprint

The strong, sleek and compact structures, achieved by an exemplary quality of construction and choice of materials, allow USM to demonstrate a great conservation of precious space.



Adaptation and Innovation

Thanks to its great ease of installation/dismantling, USM furniture is capable of forever adapting itself to the rapid evolution of technical equipment. Retrofittable at any time.



Low Cost of Use

The outstanding durability and adaptability of USM, as well as the possibility of endlessly reconfiguring furniture regardless of initial function, guarantee a reduced cost of use over time.



Sustainable Development and HQE Standards

USM was the first company in Europe to receive the Greenguard international certification by creating furniture that is coherent with the environmental initiatives of buildings. In 2018, USM Haller and USM Kitos M achieved Cradle to Cradle® certification.

Founded in 1885, the USM family-owned company is now managed by the fourth generation. Synonymous with adaptable, timeless design, the USM brand stands for quality and precision, high-quality raw materials, meticulous artisans and unconditional dedication. Driven by customer interest and respect for the environment.



Sustainable production in harmony with nature

Our manufacturing site in Münsingen is located in the heart of a diverse cultivated landscape. We have designed around 7,000m² of the surrounding area to be close to nature – creating a valuable habitat for native plants, animals, and birds. For this commitment to promoting biodiversity, we were recognised by the Nature & Economy Foundation – a testament to our responsibility towards nature and the environment.



Home

12

13

15

27

39

51

61

69

77

87

Living Room

Dining Room & Kitchen

Form follows you

Media

Bedroom

Furniture that grows with you →

Kid's Room

Shelving

Storage Space

Home Office

More than functional

Silent space

Beautiful from every angle

Space for your ideas



1



Living Room

*A reflection
of your lifestyle*

Customised living room

With USM Haller, there are no limits to your creativity in the living room. From small occasional furniture to timeless sideboards and shelving, USM integrates perfectly into your unique home.



USM Haller Soft Panel



The USM Haller Soft Panel playfully integrates a textile feel into the metal world of the classic using the phenomenon of magnetism. Smart simplicity – no assembly required, just click, flip or slide.

*A soft touch
to the classic*

USM Haller E



Light up the things you love. USM Haller E integrates lighting directly into the furniture structure, wireless, dimmable, energy-efficient and almost invisible. Revolutionary!



3



4



5



6



7





9

*Bring your home
to life
with plants*

A world of plants for USM Haller





12



13

Mood lighting made
effortless



14

Dining Room & Kitchen



*If you dream it,
we can build it*

Inviting dining room and organised kitchen

Using USM Haller, you can display your finest crockery, organise all your kitchen utensils, design a customised sideboard or entertain guests at a large, elegant table.



*Let storage
be more
than functional*

Inos accessories



Inos accessories are perfectly tailored to the internal dimensions of USM Haller and ideal for storing cutlery and kitchen utensils in a clever, tidy way.

USM Inos box



The USM Inos box is available in four sizes to suit your needs, matching the dimensions of USM Haller. The interior can be divided with metal inserts.



16



17



18



19





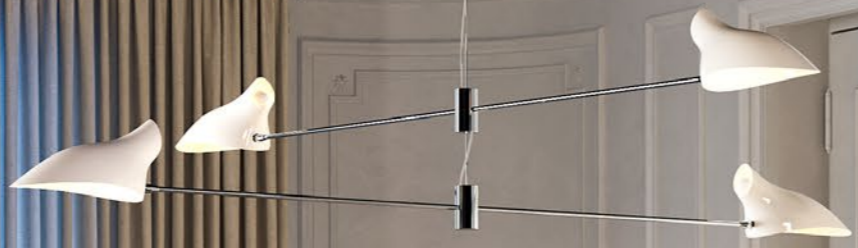

22

Let your favourite objects shine
USM Haller E



23



24

A table for life

USM Haller table





STEAMIN' WITH THE MILES DAVIS QUINTET

SON HOUSE

FRANK BRUNNE

Media

Customised media furniture

Design customisable storage for your electronics or vinyl collection – and adapt it anytime as your technology or tastes evolve.

*Icons that fit
your tech and taste*



Extension shelf



Cable cut-out



Drawers and extension shelves provide easy access to your appliances at any time. The cable cut-out helps you organise your power supply and keep it neatly out of sight.



Extension door with metal box insert

*No mess - no stress
just smart solutions*



29

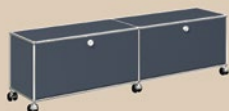

30



31



32



33



34



35



36

*Stack it
Store it
Sort your space*

USM Inos box



38

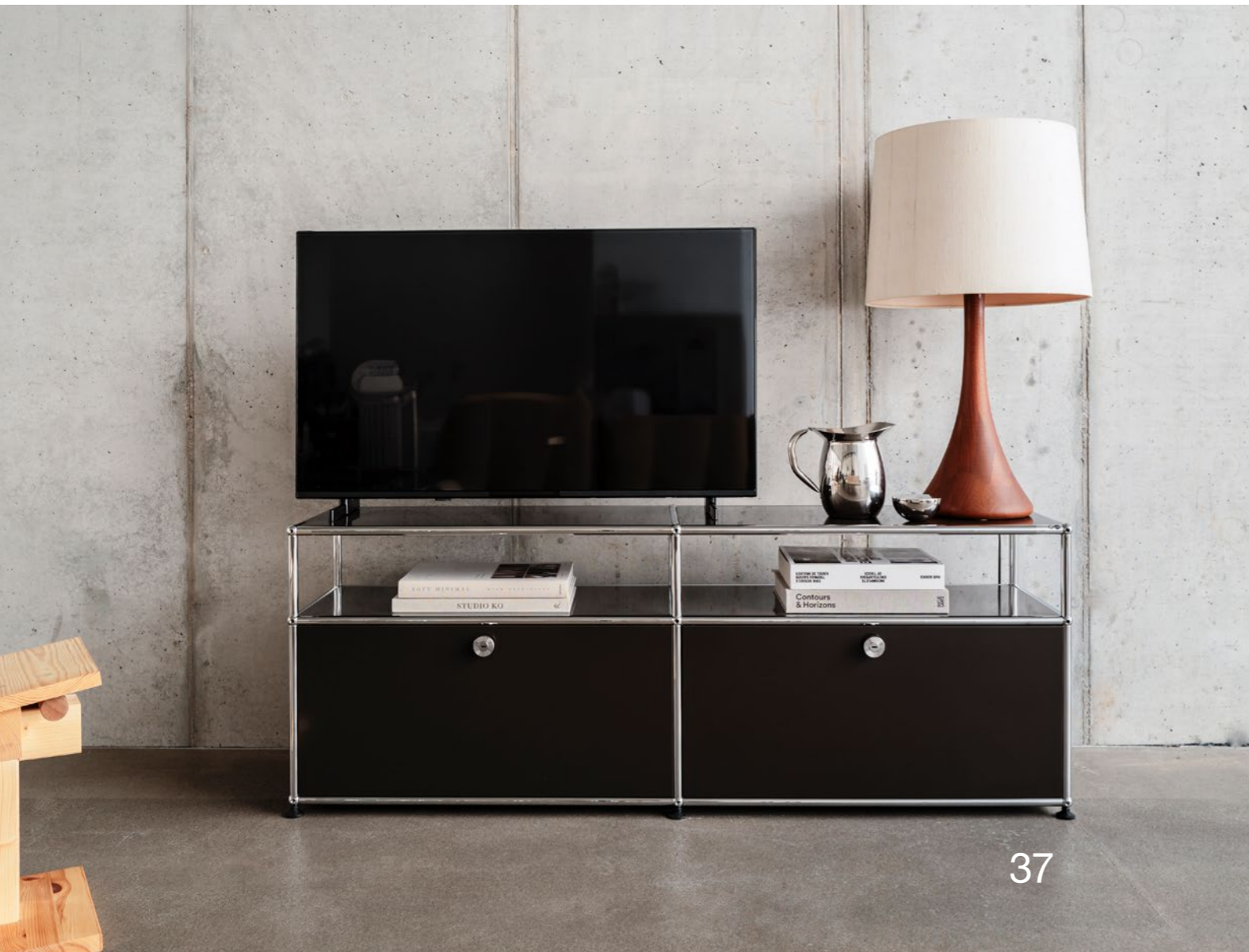

37

*Design
that adapts to
your
rhythm*





*Beauty
and functionality
from all sides.*

42



*There is power
in stillness*

Bedroom

Relaxing bedroom

Form follows you: create your own personal retreat, where you can relax and recover. Storage solutions, bedside tables, chests of drawers and shelves, all in a timelessly simple design.



43

*Tidy space -
clear mind*

Extension door with metal box insert



USM Inos box



The USM Inos box is the perfect solution for organising and dividing the interior of your USM furniture – compact and stackable.

Pull-out elements with metal box inserts of varying heights offer a smart alternative to drop-down doors, providing clear visibility and easy access to your wardrobe pieces.



44



45



46



47



Make it yours

Prefer a different width or height? Configure it online.



www.usm.com



48

49





50



51



52



53

*Freedom
in every direction -
360° creativity*



Kid's Room

Kid's room full of imagination

Build colourful furniture that grows with your family. Start with a toy box that transforms into a desk as your child grows into a teenager. Greenguard certified for low chemical emissions, it's a valuable companion for generations to come.

*Growing lives,
shifting interiors*





USM Haller Soft Panels



Toy box with handle

USM Haller Soft Panels add a playful touch to kids' rooms. The magnetic panels can be clicked into the structure without any installation effort, flipped up or down, and the narrow Soft Panels can be slid into the 750 mm axes. So simple, so fun and so colourful!

*Play with colours
and texture*



56



57



58



59





60



61

*Never too young
to love design*



62

←
*From playtime to
 study time -
 what's next?*



64

63





65

*Make your shelves
as individual
as what they hold*

Shelving

Flexible shelving

USM shelving has no fixed size and fits seamlessly into any environment. From open bookcases to customised wall shelving and freestanding room dividers: storage solutions designed to suit your tastes and needs, adaptable at any time.



Securely store and manage lock access by the app

Lock C for USM Haller



With the electromechanical lock C and the specially developed USM app, storage space and lock management take on a whole new dimension. The lock C can be operated intuitively and easily via the USM app.

Glass elements



Protect the things that matter to you. Glass doors and shelves turn your shelving into a display case, adding a sense of lightness and refined transparency to any piece of furniture.

Display in style



67



68



69

70





71



USM Haller Soft Panels

*Magnet magic -
elevate your classic
with a soft texture*

72



73



Compact workspace - perfectly blended

74

75



*Tailored solutions
you never knew you
needed*

Storage Space

Customised storage space

From the hallway to the living room and bathroom, USM storage solutions adapt elegantly to every space and purpose. As an expandable system, they evolve with the rhythm of your life.



USM Inos box



USM Inos drawer set



Inos accessories

USM Inos boxes are the perfect solution for organising and dividing the interior of your USM furniture – compact and stackable.

Inos accessories are designed to fit the internal dimensions of USM Haller. Easy to care for and versatile.

The USM Inos drawer sets with 5 drawers are available in all 14 standard colours.

*Space within
a space
for perfect organisation*

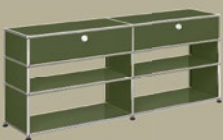

77



78



79



80



81



82



83



84



85





Home Office

*Designed to work,
built for life*

Inspiring work at home

Feel comfortable while you work from home. An aesthetically pleasing home office environment not only inspires, but also promotes well-being and motivation. USM brings quality to the home office and enhances your life.



USM Inos box



USM Inos boxes made from soft-looking polyester fleece can be divided as desired using metal partitions.

Compact and multifunctional

Extension shelf



Ready when you are. Perfect for pop-up workspaces and ultra-compact home office solutions: extension shelves provide functional workspaces in next to no time – just when you need it.



90



91



92



93



94

*Workspaces with
a homely touch*





96



97



98

*Space-saving
design for
boundary-free
working*



100



99



101

↑
↓
*Sit to stand -
zero electricity*
USM Kitos M

Work

98

99

101

Welcome Focus

Hybrid usage

111

Case study

127

Collaborate

*Comfort
Concentration
Coffee*

133

Meet

147

Organise

Future-proof

*Adaptable by design,
valuable
for the long term*

159

*Embrace change
~~design~~
restrictions*

- Individual*
- Iconic*
- Interchangeable*

102

**360° of functionality
and design**

A USM reception has no front or back – it is functional and aesthetically pleasing from every angle. It can be easily retrofitted at any time, for example with safety features. The USM product range offers solutions for almost every need.

*... Because
first impressions
matter...*

Welcome

A warm welcome

The reception is the point of contact for employees, welcomes visitors and creates a lasting first impression. Design options for reception desks and multifunctional waiting areas are limitless.



*Refined presentation,
resilient surfaces*

Glass countertops



Back-painted glass countertops in standard USM Haller colours are the ideal choice for heavily used surfaces – robust, low-maintenance and perfectly colour-coordinated.

Angled shelves



Angled shelves provide the perfect way to showcase company brochures at reception or magazines in the lounge area. Ample storage space is cleverly hidden behind the elegant flip-up elements.



104



105



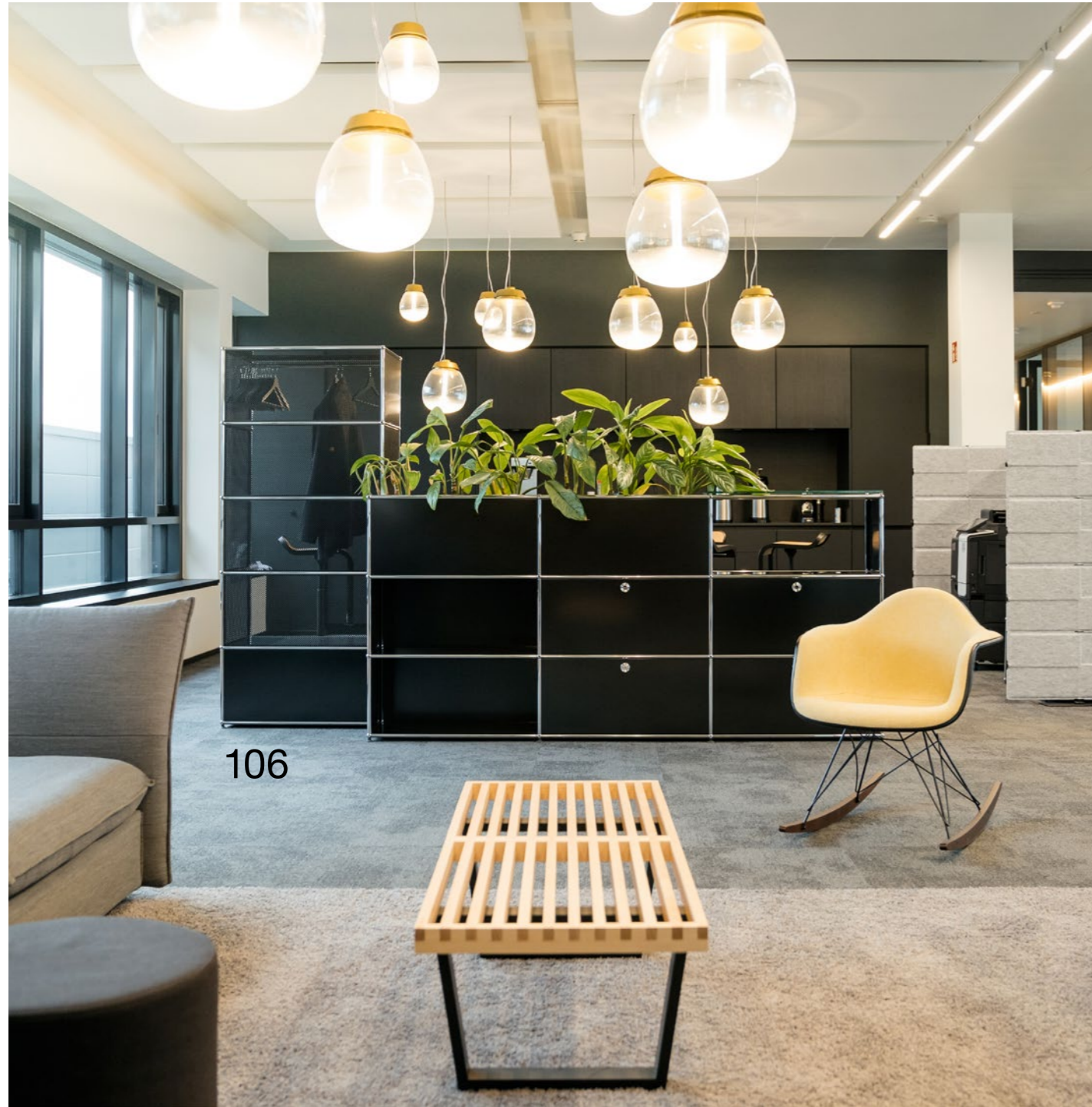

*Freestanding
solutions - functional
and beautiful
from every angle*



A clean appearance

Sleek from the front, multi-functional at the back, the glass perfectly showcases beautiful items. Customise your reception with drawers and shelves for added organisation.



*Flawless on the outside,
perfectly organised
within*



108



109

Work

108

109

Welcome

110

*Divide your space -
multiply
its purpose*



Expressive

High shelving, a long sideboard and a large desk, all in elegant materials. USM modular furniture offers flexible solutions to meet your needs.



*Let your
work culture speak
volumes*

Focus

Customised individual workstations

The office can be customised with USM, as can hot-desking workstations with height-adjustable tables for ergonomic working. USM adapts to your way of working.



*Designed for quiet,
built for privacy*

USM Privacy Panels



Acoustic panel



Perforated panels with sound-absorbing fleece offer a noticeable improvement in acoustics. As well as optimising room acoustics, USM Privacy Panels also create clear structures and quiet zones for focused work, whether freestanding or added to a tabletop.



113



114



Sit to stand solution

The USM Kitos M table is manually height-adjustable. Its elegant black linoleum tabletop contrasts beautifully with splashes of colour.



115



Connectivity

Added value: the tabletop adaptation points allow easy connection of accessories such as desk lamps and USB ports and provide cable access beneath the slidable tabletop.



116

Lock securely, share easily

Storage units can be securely locked, keeping confidential documents safe. With the electromechanical lock C, you can easily manage colleague access via the USM app – perfect for remote working.



117

*Smart sound
solutions with a
fun twist*

USM Haller Soft Panels

Work

120

121

Focus



118

*Experience the strength
of elegance*



119

Tear down the walls

Who needs walls when you can easily design room dividers tailored to your team's needs? The gentian blue central unit doubles as a multimedia library and encourages collaboration.

*Sit to stand -
zero electricity*

USM KITOS M



Hot desking

Employees can choose a free workstation at the long desk. Computer monitors are mounted in the adaptation points of the USM Haller tables. Simply connect in and off you go.

Created to fit your space





122

Sustainable Development

think
re
design
value



Norvento reinvents its workspace

With over four decades of experience in renewable energy and energy efficiency, the Spanish company Norvento Enerxía demonstrates its ongoing commitment to innovation and the environment at its headquarters.

In 2016, the company constructed a zero-energy building in Lugo, northern Spain, designed by architect Francisco Mangado.

This project had four key requirements: environmental responsibility, employee comfort, scalability for future growth, and reflecting the design passion of Norvento President Pablo Fernández Castro.

To meet these requirements, Norvento chose the USM modular furniture system for its headquarters, known for its outstanding modularity and durability.

The system seamlessly integrated into the workspace and met the company's expectations for adaptability and design.

As Norvento has grown and changed over the years, the company recently redesigned its office to better accommodate new workflows and promote greater collaboration. Instead of replacing the existing furniture, Norvento transformed its workspace into a completely new environment by reconfiguring the USM Haller systems.

The original furnishings were easily dismantled and reassembled to create new breakout areas, flexible collaboration spaces, and seating areas. Furthermore, the installation of planters, as well as perforated and sound-absorbing panels, improved acoustics and created an environment conducive to well-being, creativity, and performance.

As the centerpiece of Norvento's redesigned workspace, they provide added value, enhanced comfort, and reflect the company's commitment to sustainability and innovation.



The newly configured furniture demonstrates the adaptability and timeless quality of this classic modular design.

Original office 2016



Sustainable Design

During its lifetime, USM can be redefined time and again – making it a lasting companion across generations.

think
re
design
value



Discover
more
exciting
stories:





123



Collabo- rate

Encouraging collaboration

Opportunities for interdisciplinary collaboration encourage team spirit and innovation. Creative zones for brainstorming, group workstations, and spaces to relax and find inspiration – with USM, you can create dynamic solutions with lasting value, where teams can truly excel.

*Fostering teamwork,
sparking innovation*



Easily connected

Adaptation points

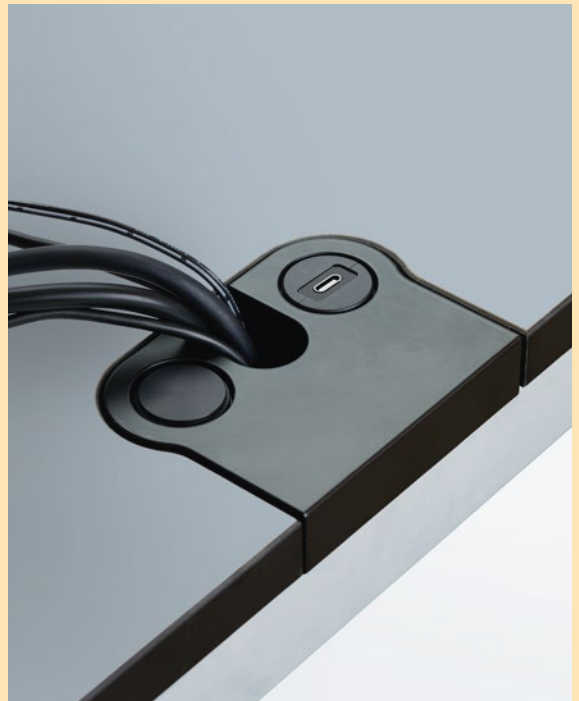

Flush-mounted adaptation points in the tabletop ensure clean cable management and accommodate accessories such as monitor arms or USB ports, using the plug-and-play principle.

Grommet hatch for network access

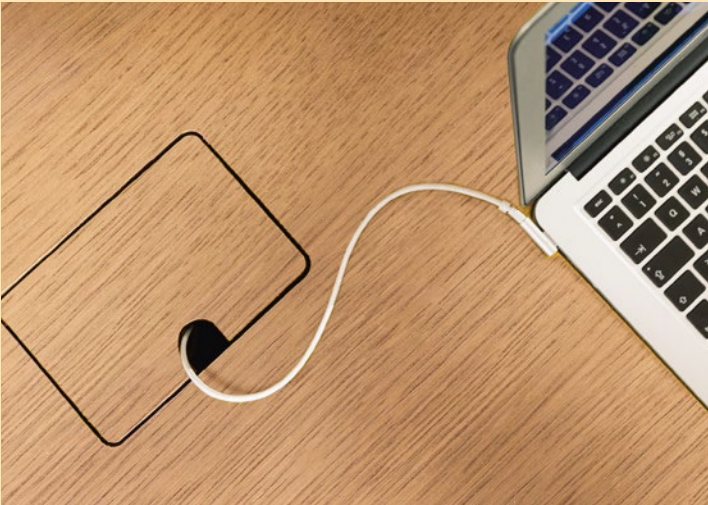

Discreet grommet hatches in the tabletop allow meeting participants to connect to power and networks at any time.



125



126



Connecting people

Today's workplace gives users the choice of where and how they want to work. Office spaces must support different ways of working – offering the flexibility to come together or meet in more focused settings. Large USM Haller tables provide employees with greater freedom in how they meet, while USM Privacy Panels create quiet zones. Central gathering points can be formed using the USM Haller modular system.



127

Streamlined offices

USM Kitos tables provide a flexible office solution for any team. The system supports both individual and collaborative work, adapting to whatever the situation requires. Manual height adjustment offers hassle-free flexibility.



One team. one table

Get together at one large desk. USM Haller offers three-metre-long desks that create work islands within a flexible workspace. Tabletop adaptation points allow maximum individualisation with smart accessories such as lamps, USB ports or protective screens, as well as hatches for network access.

128

Optimised acoustics

USM Privacy Panels have been proven to improve room acoustics, adding value when dividing open-plan spaces into different zones.



129



130

Modular zoning - freedom beyond fixed walls

Make it yours

Prefer a different width or height? Configure it online.



www.usm.com

131

*One team
one table*





Ready to serve

Possibly the most compact tea station in the world – you can even fit a small refrigerator in it!

132



133

Snack bar

This green USM Haller unit is accessible from both sides. It provides storage and a countertop, making it the perfect office kitchen solution. Additional drawers, doors, dividing shelves and smart accessories can also be added.

*Offices that keep pace
with you*

134



135



Supersized table

Enjoy a generously proportioned table at a comfortable height. The USM Kitos M Meeting table is made for ad-hoc standing meetings of up to eight people and is easily manually height-adjustable.

Meet

*From brainstorm
to boardroom -
solutions that work*

Dynamic meetings

Whether improvised around a large standing table or held formally in an elegant meeting room, adaptable solutions from USM connect people and integrate media technology with ease.



*Extra-large tables
with manual height
adjustment*

USM Kitos M Meeting



The USM Kitos M Meeting is the first mechanically height-adjustable meeting table that is both supersized and extra stable. Its tension spring mechanism, which lasts much longer than a conventional gas pressure system, adjusts quickly and easily.

Acoustic panels



Perforated metal panels with a fleece-covered interior: acoustic USM Haller elements significantly reduce background noise, thereby improving the overall work environment.

*Good acoustics
elevate
every meeting*



137



138



139

Multipurpose

Meeting areas can host video calls, presentations, strategy meetings and even serve as a place to catch up with colleagues over a coffee break.

Work

150

151

Meet

140

Meeting, presenting,
teamwork

The USM Kitos M Meeting extra-large table is manually height-adjustable, providing the ideal meeting setting. A media unit holds all the necessary technology.



Bring your meeting space to life with plants



Multimedia, multi-use

Frame screens and technical equipment with an eye-catching shelf. Small individual tables can be moved within the space for different meeting configurations.



Work

Make your meetings more dynamic

Instead of one large meeting table and stationary furniture, go for smaller tables and storage units on castors. Quickly rearrange the space into exactly the right configuration for any occasion.

154

155

Meet

143

*Quietly effective:
acoustic elements that
absorb sound*





144

Meeting spaces

Smaller tables can easily be integrated into the office landscape, creating useful spots to meet and chat.



145

Focus corner

With the modular system USM Haller, you can also create spaces for focused work or confidential conversations. Thanks to the acoustic panels, the necessary privacy is ensured.

146



*Multifunctional
with bold character*

Organise

Rethinking organisation

Sustainable storage space fulfils several functions. Design lockers to double as benches and turn the central document storage area into a green island. From mobile pedestals to shelving with integrated screens and modular technology zones, USM can accommodate any idea.



Metal magnetic bookends



Lock C for USM Haller



With the electromechanical lock C and the specially developed USM app, storage space and lock management take on a whole new dimension. The lock C can be operated intuitively and easily.



Inos accessories

Manage locker access with the app



148



149





*Let storage
breathe life into
your office*



151

Connectivity

With the USM app, the electro-mechanical lock C can be managed intuitively and easily using three different user modes. Keep private items securely locked or allow colleagues access.

*Keep it personal –
mobile storage
for open-plan offices*



152



153

Every employee deserves their own storage space – an impressive wall shelving solution delivers that.

Personal lockers with added comfort



154



Beyond

Next space

168

169

170

Hospitality

Maximum versatility

174

Retail

Premium presentation

182

Museum

184

Library

Perfect organisation

Fluid spaces

...

...

...

Hybrid places

and beyond...

Make it whatever you want it to be



蒋经理
团队













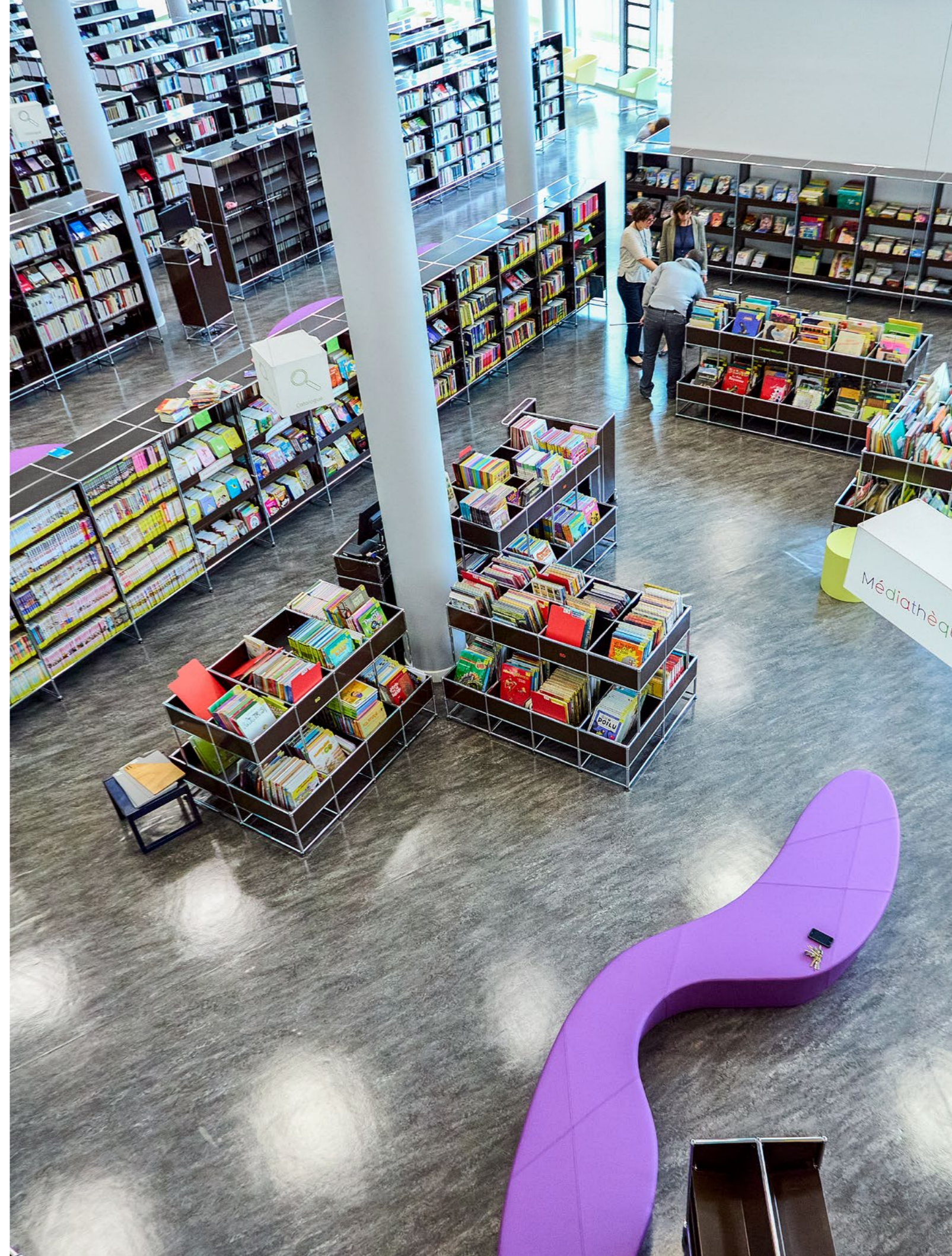

USM Haller

The design icon, since 1965. The modular concept combines functionality, durability and sustainability with timeless aesthetics. Design a classic that is customised to your needs – at home, at work and in public spaces.

Classic, timeless aesthetics, maximum adaptability, and smart accessories ensure a long lifespan across generations.

World of plants
Indoor climate



World of plants for a healthy climate

Plants improve the indoor climate and in turn our working environment. With the world of plants for USM Haller, lively evergreen landscapes can now be easily integrated into the structure of USM Haller.

Soft
Magnetic



A soft touch to the classic
The USM Haller Soft Panel playfully integrates a textile feel into the metal world of the classic, using the phenomenon of magnetism. Smart simplicity – no assembly required, just click, flip or slide.

The original
Swiss quality
Modular
Future proof
Sustainable



Storage management



Lock securely, share easily
With the electromechanical lock C and the specially developed USM app, storage space and lock management take on a whole new dimension.

Light
Charging
Wireless



USM Haller E

Light up the things you love. USM Haller E integrates lighting and USB ports directly into the furniture structure, wireless, dimmable, energy-efficient and almost invisible. Revolutionary!

USM Haller

The USM Haller system provides a wide variety of elements in standard sizes. Widths, depths and heights are indicated below. All measurements refer to the distance between axes.



Your safety matters to us. Check out the USM safety instructions now. www.usm.com/safety

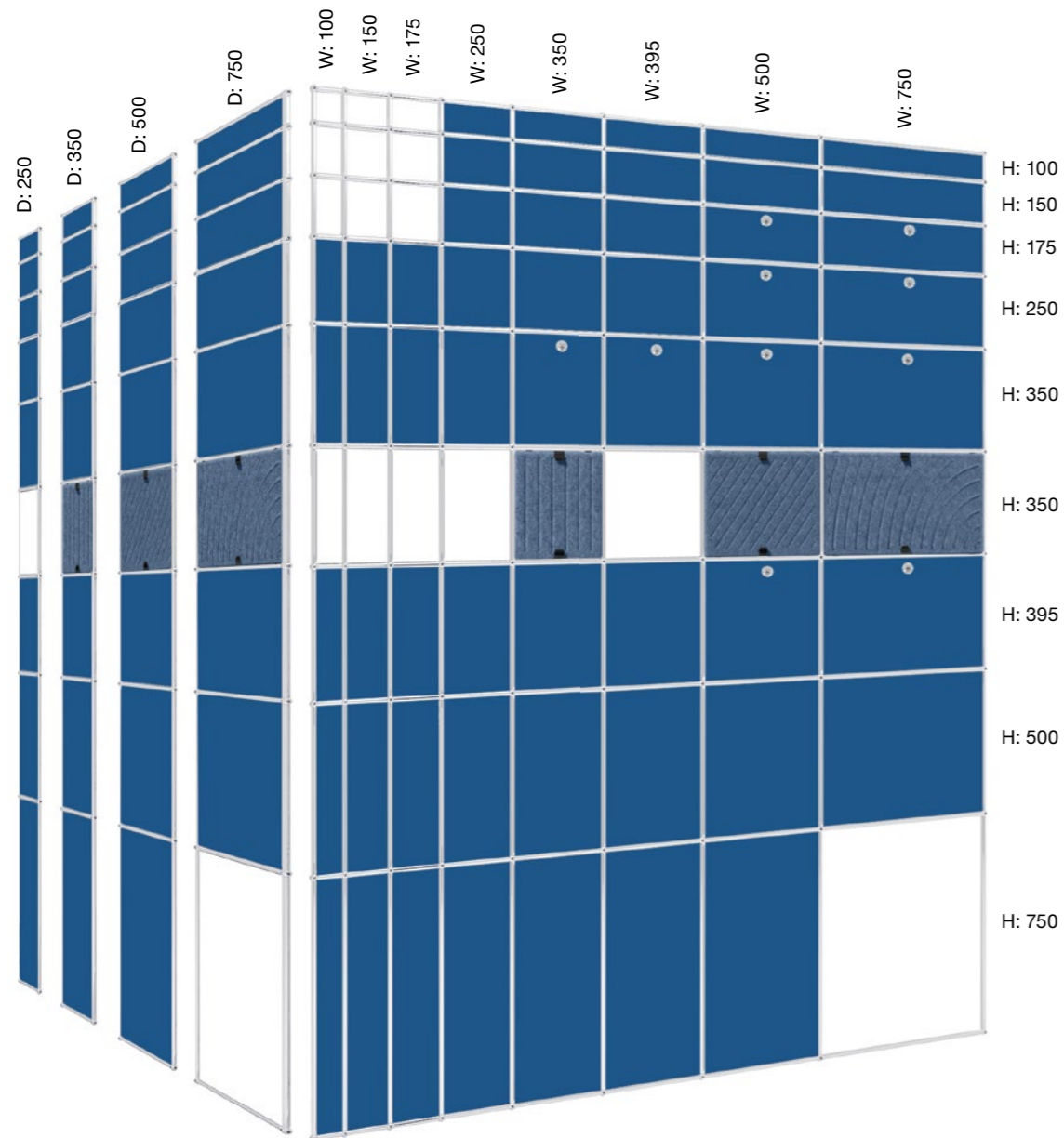
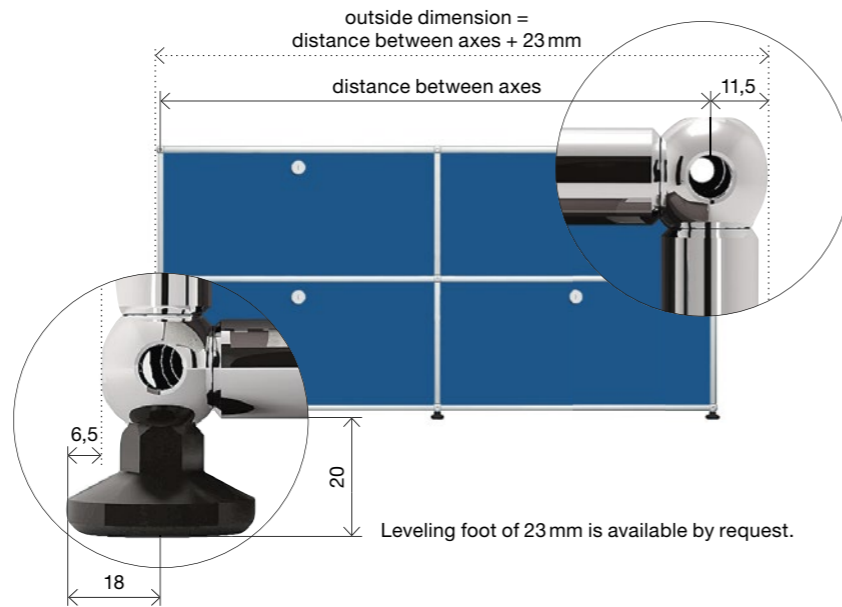

All measurements in mm.

- 1 Metal panel
- 2 Glass panel
- 3 Acoustic panel
- 4 Perforated metal panel
- 5 Metal flip-up door
acoustic version available
- 6 Cable cut-out
- 7 Glass door
- 8 Acoustic drop-down door
- 9 Metal drop-down door
- 10 Metal extension door
acoustic version available
- 11 USM Haller Soft Panel magnetic
- 12 Metal divider shelf
- 13 Glass divider shelf
- 14 Metal angled shelf
- 15 Extension filing set with extension shelf
- 16 Metal plant panel with circular recesses to hold the pots
- 17 Metal extension shelf
- 18 A5 drawer D: 500
- 19 A4 drawer D: 500
- 20 Small drawer D: 500
- 21 A6 drawer D: 500
- 22 Hanging file baskets
- 23 Metal box insert
- 24 USM Inos box
- 25 Bookend for bookshelf panel (D: 350)
- 26 Metal magnetic bookend
- 27 USM Inos CD tray
- 28 USM Inos drawer set, open
- 29 USM Inos drawer set, closed
- 30 USM Inos angled file trays
- 31 USM Inos drawer organiser set

Start configuring your individual piece of USM now! www.usm.com

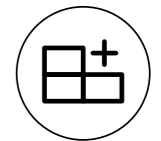
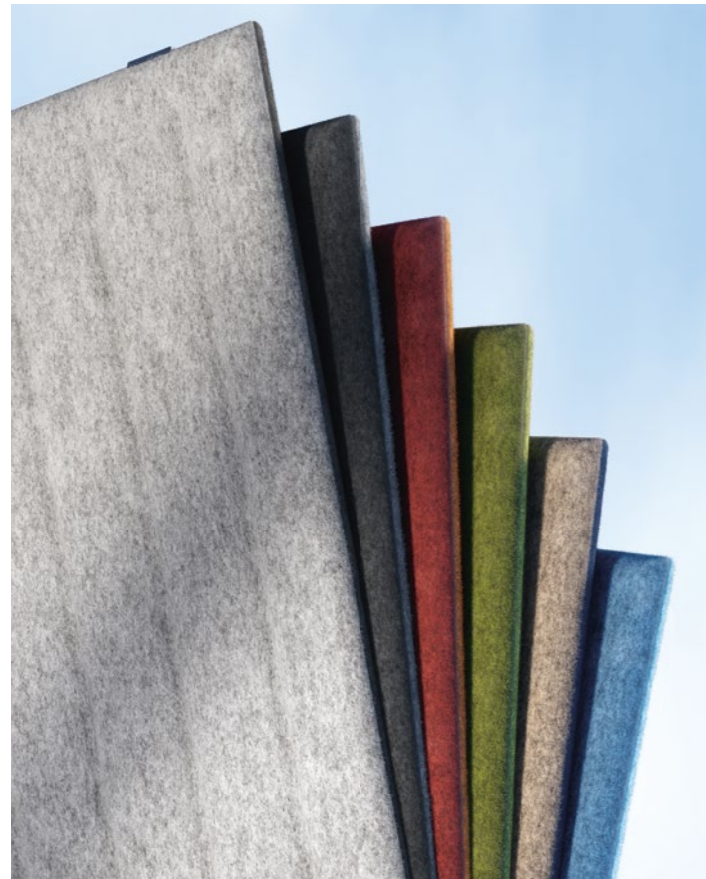

Illustration: USM Haller in D: 500 mm. All measurements in mm.

USM Haller Soft Panel

The USM Haller Soft Panel adds a soft and playful touch to the USM product range. The textile panels come with four magnets and can be easily clicked into the tubular structure of the modular furniture system – no assembly or additional fixtures required. It's just as easy to fold them up or down to open and flip into the next compartment. And of course you can turn things round at any time or position them somewhere else in the furniture.

The USM Haller Soft Panel is made of high-quality synthetic fibre, with 40% recycled marine plastic. Lightweight, stable and renowned USM durability. Soft to the touch and a warm aesthetic – providing a surprising contrast in the metallic world of the classic design. Another special feature: the panels reduce noise and improve room acoustics. This is typical USM: design, functionality and sustainability in symbiosis.



Polyester fleece with 40% recycled marine plastic content

Ready to retrofit

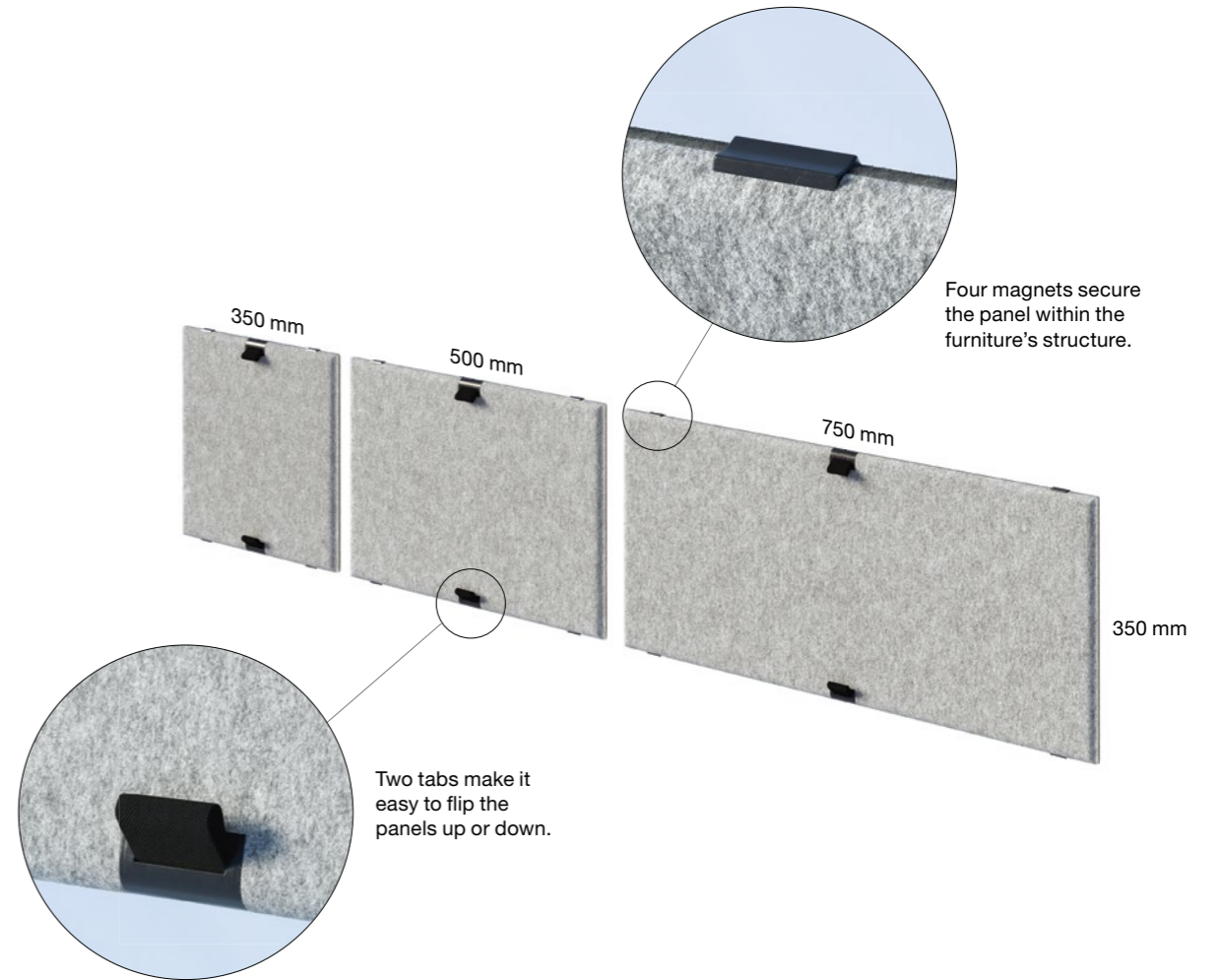

There are three patterns to choose from: curved, diagonal and vertical grooves.

Mono Panels are designed with the same pattern on both sides (either diagonal or curved grooves) and in a single colour. Available in 6 colours.



Mono Panel curved – side 1

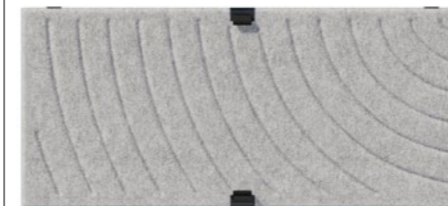

Mono Panel curved – side 2



Mono Panel diagonal – side 1



Mono Panel diagonal – side 2

Duo Panels have vertical grooves on one side, are plain on the back and available in 6 various colour combinations.



Duo Panel vertical – side 1



Duo Panel plain – side 2



USM Haller E

192

193

The modular structure of your design, either completely or partially equipped with e-Balls and e-Tubes, is connected to a source of electricity. The structure itself conducts the low voltage electricity to the desired location using the e-Balls, e-Connectors and e-Tubes to form a circuit. USB chargers or light sources can be snapped into place in pre-cut recesses. The power supply is drawn from any point near the ground. The power supply cable is attached to an e-Ball, and the power adapter is subsequently tucked underneath the furniture until only the operating switch remains visible. From this point, the power supply requires no further cables as it is integrated into the structure of the furniture.

Application options

- 1 Glass panel**
Glass elements can be illuminated throughout.
- 2 Without metal paneling**
Compartments without metal paneling can be completely illuminated.
- 3 With metal paneling**
Compartments with metal paneling can be illuminated from the front.
- 4 Compartment with an extension shelf**
The entire compartment with an extension shelf can be illuminated.
- 5 Drop-down and extension door**
Via the "Light When Compartment Is Open" function, the light automatically turns on when the door is opened.
- 6 Angled shelf**
The presentation space is illuminated from the front.
- 7 Floor lighting**
With floor lighting, the light shines at a 25-degree angle under the furniture.
- 8 Ambient lighting**
The light is directed vertically towards the back, illuminating the surroundings with a warm glow.
- 9 e-USB charger**
It can be integrated in the same places as the e-Lights.

e-Elements

- 1 e-Lights**
Dimmable, available in
– Warm white 2700 Kelvin
– Cold white 5700 Kelvin
Both with or without the "light at compartment opening" function.
- 2 e-USB charger**
Provides a voltage of 5 volts to the connected device. (Capacity: 6.5 W)
- 3 e-Dummy**
Sleek, black e-Dummy element, closes recesses that are unutilised. Can be changed for additional e-Lights or e-USB charger later.
- 4 e-Tube (power outlet)**
Tubes with recesses for e-Lights, e-USB chargers or e-Dummy elements that can be easily snapped into place or replaced.

L 350, 1 recess
L 500, 2 recesses
L 750, 3 recesses
- 5 e-Tube (conductive)**
The conductive e-Tube serves to conduct the electricity if no inserts are desired in this location. It is available in lengths of 750, 500, 395, 350, 250 and 175 mm.
- 6 e-Ball, e-Connector**
To enable the flow of electricity, the ball and connector were refined. The exterior dimensions remain unchanged. The distinguishing feature of the ball is the black insulation ring.
- 7 e-Power supply**
Includes dimmer at the operating switch. Transforms the power supply voltage to 24 volts. (Capacity: 60 W)

CE

Engineered & Made in Switzerland.

Only available in certain countries. Please contact USM Switzerland for availability in your country.



Winner of the German Design Award 2019 for outstanding design quality in the Office Furniture category



Winner of the Wallpaper* Design Awards 2018



Winner of the Focus Gold Award 2018 for outstanding design quality



Winner of the Muuz International Award 2018 in the furniture category



Winner of the FX Design Awards, Lighting Product 2017



USM Haller Tables

The classic par excellence: USM Haller tables are stylish and durable. Whether as a timeless dining table, a highly individual work desk, or in an elegant meeting room, they make a strong impression. Their timeless elegance ensures they pair well with other pieces from the USM Haller collection. Legs and frames made of chrome-plated steel ensure maximum stability, while high-quality, hard-wearing surfaces and high-precision by Swiss specialists guarantee a long service life.



Living
Lounge

USM Haller Side Table
Square or rectangular, design the perfectly proportioned coffee table. Choose a surface that blends into your living room.



Dining
Home office
Office
Meeting

USM Haller Classic
Perfectly coordinated with the USM Haller modular furniture system, with its clean lines and versatile surfaces, the table is just as suitable for offices as it is for a dining table. Elegant, timeless and iconic.



Office

USM Haller Plus
The USM Haller Plus Table has two removable adaptation points, allowing accessories to be quickly and easily mounted for streamlined cabling.

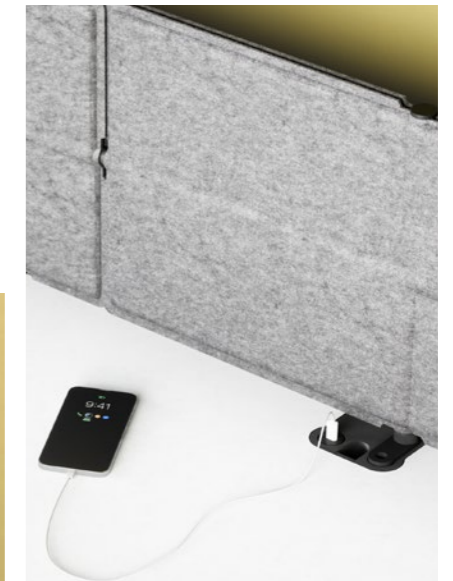





Office
Executive office

USM Haller Advanced
The most convenient table type: the tabletop slides forward for easy access to the integrated cable tray. Adaptation points can be fitted with smart accessories and USB ports.

USM Haller Tables

The USM Haller and USM Haller Plus tables can be equipped with an optional cable basket underneath the tabletop, while the USM Haller Advanced features integrated smart solutions for electrification. All tables can be equipped with grommet hatches for network access.

Basic table	Sliding tabletop + adaptation points	Working table	Side table
Optional cable basket underneath the tabletop	Integrated cable tray accessible from above by sliding back the tabletop Adaptation points for accessories	Optional cable basket underneath the tabletop Removable adaptation points for accessories	
			
USM Haller	USM Haller Advanced	USM Haller Plus	USM Haller Side table
H: 740 L: 3000 / D: 1000 L: 3000 / D: 750 L: 2500 / D: 1000 L: 2500 / D: 750 L: 2250 / D: 1000 L: 2250 / D: 750 L: 2000 / D: 1000 L: 2000 / D: 750 L: 1750 / D: 1000 L: 1750 / D: 750 L: 1500 / D: 1000 L: 1500 / D: 750 L: 1250 / D: 1000 L: 1250 / D: 750 L: 1000 / D: 1000 L: 750 / D: 750	H: 740 L: 2000 / D: 1000 L: 2000 / D: 750 L: 1750 / D: 1000 L: 1750 / D: 750 L: 1500 / D: 1000 L: 1500 / D: 750 L: 1250 / D: 1000 L: 1250 / D: 750	H: 740 L: 3000 / D: 1000 L: 3000 / D: 750 L: 2000 / D: 1000 L: 2000 / D: 750 L: 1750 / D: 1000 L: 1750 / D: 750 L: 1500 / D: 1000 L: 1500 / D: 750 L: 1250 / D: 1000 L: 1250 / D: 750	H: 370 L: 2500 / D: 1000 L: 2500 / D: 750 L: 2250 / D: 1000 L: 2250 / D: 750 L: 2000 / D: 1000 L: 2000 / D: 750 L: 1750 / D: 1000 L: 1750 / D: 750 L: 1500 / D: 1000 L: 1500 / D: 750 L: 1250 / D: 1000 L: 1250 / D: 750 L: 1000 / D: 1000 L: 750 / D: 750

Accessories for all USM Haller Tables

- Grommet hatch for network access**
Hatch for a single power outlet, flush-mounted in the tabletop. This unit can be mounted in two different positions on the tabletop.
- Cable management**
For the USM Haller Advanced table, a cable tray integrated under the tabletop offers storage room and attachment options for all cables and technical components. For the USM Haller and USM Haller Plus table, a cable wire basket can be attached.
- Cable guide**
Is clamped to the table legs and guides cables to their outlets.
- Link chain**
Holds and directs cables to the power source. Flexible and adjustable to different lengths.
- Flat screen support arm**
Screens are mounted onto the support arm (VESA standard). Swivel-type with a spherical joint for the screen. Mounting at different heights is possible for screens weighing up to 12 kg.
- Flat screen pivot arm**
Screens are screwed to the height adjustable pivot arm using a mounting plate (VESA standard). Continuous height adjustment for screens weighing up to 12 kg.
- Front and side panel**
Can be attached under the table to the long side or laterally for modesty. For tables with lengths: 2000, 1750, 1500, 1250 and depths: 1000, 750.
- Pivoting pen holder**
Provides room for writing instruments and can be discreetly stowed under the tabletop.
- USM Privacy Panels**
Fitted on the long side of the table to provide individualisation and privacy. H: 350 or H: 700. For tables with lengths: 3000, 2000, 1750, 1500.

Accessories for USM Haller Plus / Advanced Table

- Flat screen support bar**
The support bar is inserted into the adaptation points. Up to two screens (max. 2 x 12 kg) can be attached using a mounting plate (VESA standard). Screens can be mounted at different heights; screens can be adjusted with ball joints. Continuously height-adjustable for screens weighing up to 12 kg.
 - USB adapter**
The adapter can be used for USB A 3.0 and C connections. It can easily be inserted into the adaptation point. Usable as power supply or for data transfer.
 - Lamp peg**
An optional lamp peg for easy attachment of selected table lamps. Electrification is possible through the adaptation point.
- Options
- Flat screen support bar fix**
 - Flat screen support bar adjustable**
Move forwards or backwards two notches at a time to adjust the viewing distance.

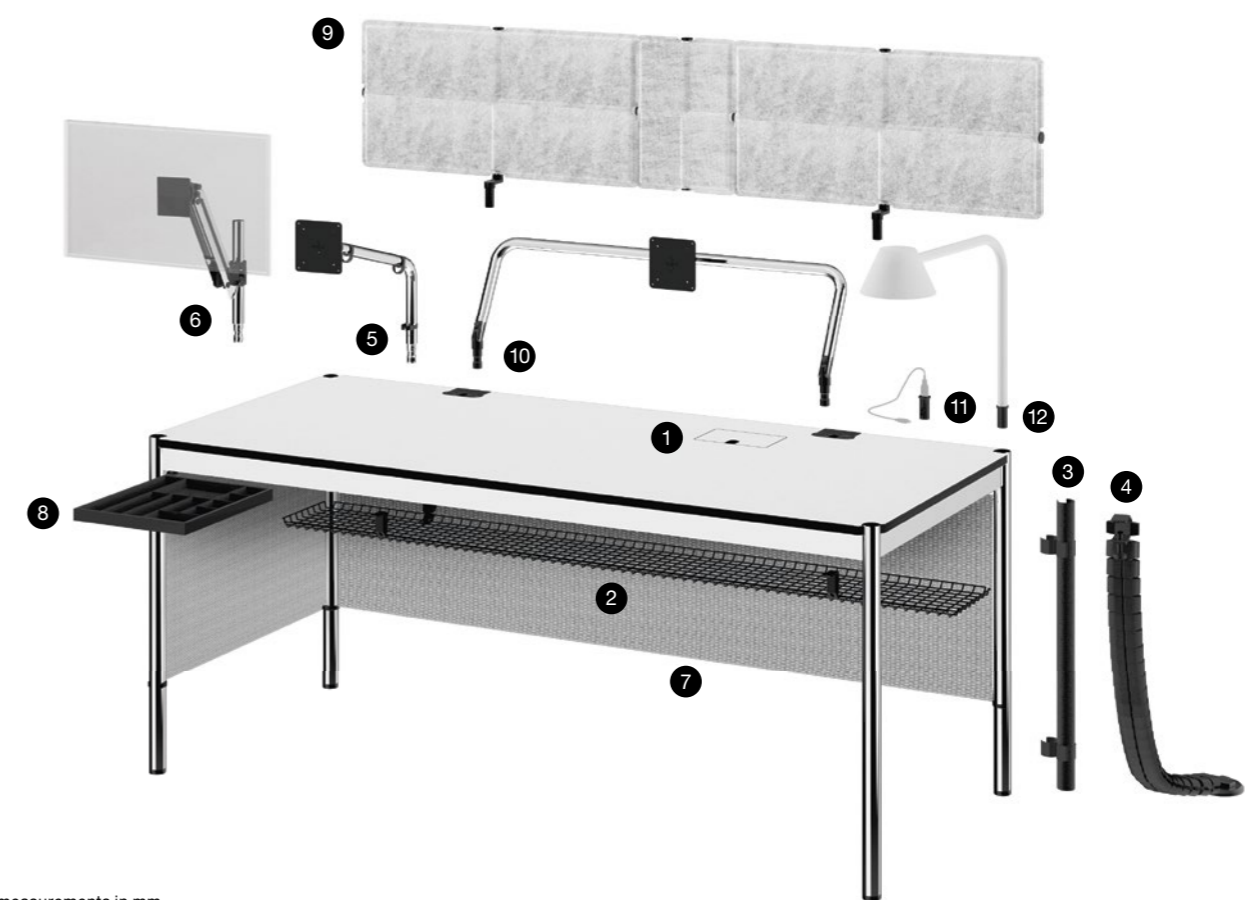

* Only available in the surfaces pearl grey laminate, black linoleum and Fenix, Grigio Londra
All measurements in mm.

All measurements in mm.

USM Kitos Tables

Continuously height-adjustable, maximum stability and customisability with smart accessories, this table allows you to work ergonomically and efficiently at all times. Ideal for sharing or as a dynamic individual workstation.

Meeting

Side table

Sit to stand



USM Kitos Freestanding

Equipped with an energy-saving height adjustment system, the freestanding round or square tables can be used for a quick meeting or temporarily transformed into a seated workstation.

Meeting

Collaborative work

Sit to stand



USM Kitos M/E Meeting

Extra-large, height-adjustable and extremely stable, perfect as a meeting table and for collaborative working. Optional grommet hatch in the tabletop provides quick network access.

Ergonomic office

Sit to stand

Highly individualised

Desk sharing



USM Kitos M

Work sitting or standing. Thanks to a patented mechanism, the USM Kitos M model adapts continuously to the user's anatomy in a matter of seconds, all without any power consumption. Perfect for sharing. Also available as USM Kitos E with electronic height adjustment.



USM Kitos M/E Plus

With this option, two adaptation points recessed into the tabletop allow for easy connection of accessories. In addition, the tabletop slides forward for quick access to the spacious cable tray underneath.

Sit to stand

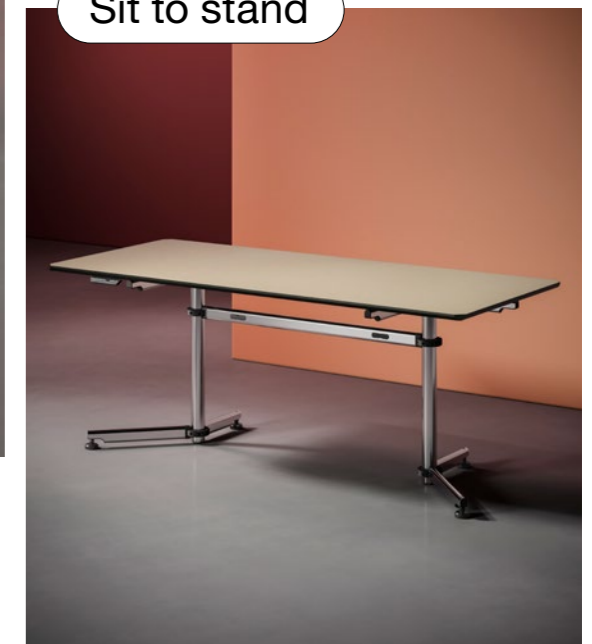

USM Kitos

An elegant workstation, meeting table or complex workstation, USM Kitos is a technical icon and electrically height-adjustable.

USM Kitos M/E Table

Each table of the USM Kitos M and E family offers integrated smart solutions for electrification, excluding freestanding.

Why USM Kitos M?

The "M" in its name stands for mechanical spring-loaded height adjustment; adjustment time approx. 1 second with zero energy consumption. This system is more than 10 times faster than the electronic equivalent and has an extremely long operating life.

Why USM Kitos E?

Maximum functionality and captivating design – USM Kitos E unites all requirements in one modern workplace: continuous height adjustability and maximum stability. A distinction is made between fixed and motor-driven legs in the E1, E2 and E3 models.

E1



H: 740
With or without middle traverse

E2 with 1 motor



H: 700–1200
Adjustment time approx. 30 sec.
With middle traverse

E3 with 2 motors



H: 650–1300
Adjustment time approx. 20 sec.
With middle traverse

Basic table

Integrated cable tray underneath the tabletop



USM Kitos M

H: 700–1200
L: 1800 / D: 900
L: 1750 / D: 750
L: 1600 / D: 800

USM Kitos E

L: 1800 / D: 900
L: 1750 / D: 750
L: 1600 / D: 800
Available with E1*, E2 or E3** columns

Sliding tabletop

Integrated cable tray accessible from above by sliding back the tabletop

Adaptation points for accessories



USM Kitos M Plus

H: 700–1200
L: 1800 / D: 900
L: 1750 / D: 750
L: 1600 / D: 800

USM Kitos E Plus

L: 1800 / D: 900
L: 1750 / D: 750
L: 1600 / D: 800
Available with E1*, E2 or E3 columns

Extra size

Integrated cable tray underneath the tabletop and accessible from all sides



USM Kitos M Meeting

H: 700–1150
L: 2500 / D: 1000
L: 2250 / D: 1000

USM Kitos E Meeting

L: 2500 / D: 1250
L: 2500 / D: 1000
L: 2250 / D: 1000
Available with E1, E2 or E3 columns

Side table



USM Kitos Freestanding

H: 740 or 700 – 1110
Square
L: 750 and 900
Round
Ø: 900 and 1100

The table can also be provided with an asymmetrical version of the middle traverse, for extra legroom. (This is not possible with the USM Kitos M/E Meeting.)

* Available with or without middle traverse.

** Available in a GS-Mark tested version with 3 mm table edge radius and the asymmetrical middle traverse.

All measurements in mm.

Accessories for all USM Kitos M/E Table

- Grommet hatch for network access**
Hatch for a single power outlet, flush-mounted in the tabletop. This unit can be mounted in two different positions on the tabletop.

- Link chain**
Holds and directs cables to the power source. Flexible and adjustable to various lengths.

- USM Privacy Panels**
Fitted on the long side of the table to provide individualisation and privacy. H: 350 or 700. For tables with lengths: 2500, 2250, 1800, 1750, 1600.

Accessories for all USM Kitos M/E Table, except USM Kitos M/E Meeting

- Flat screen pivot arm**
Screens are screwed to the height adjustable pivot arm using a mounting plate (VESA standard). Available for USM Kitos E and M tables: the pivot arm is mounted onto the tabletop using the universal support.

- Front panel**
Can be attached under the table to the long side. For tables with lengths: 1800, 1750, 1600.

- Material tray**
Provides room for writing instruments and can be discreetly stowed under the tabletop.

Accessories for USM Kitos M/E Plus Table

- Flat screen support arm**
Screens are mounted onto the support arm (VESA standard) which can be connected directly to one of the adaptation points. Swivel-type joint for the screen. Mounting at different heights is possible for screens weighing up to 12 kg.

- Flat screen support bar**
The bracket is inserted into the adaptation points. Up to two screens (max. 2 x 12 kg) can be attached using a mounting plate (VESA standard). Screens can be mounted at different heights; screens can be adjusted with ball joints.

- Options:
- Flat screen support bar fix**
 - Flat screen support bar adjustable**
Move forwards or backwards two notches at a time to adjust the viewing distance.
 - USB adapter**
The adapter can be used for USB A 3.0 and C connections. It can easily be inserted into the adaptation point. Usable as power supply or for data transfer.

- Lamp peg**
An optional lamp peg for easy attachment of selected table lamps. Electrification is possible through the adaptation point.

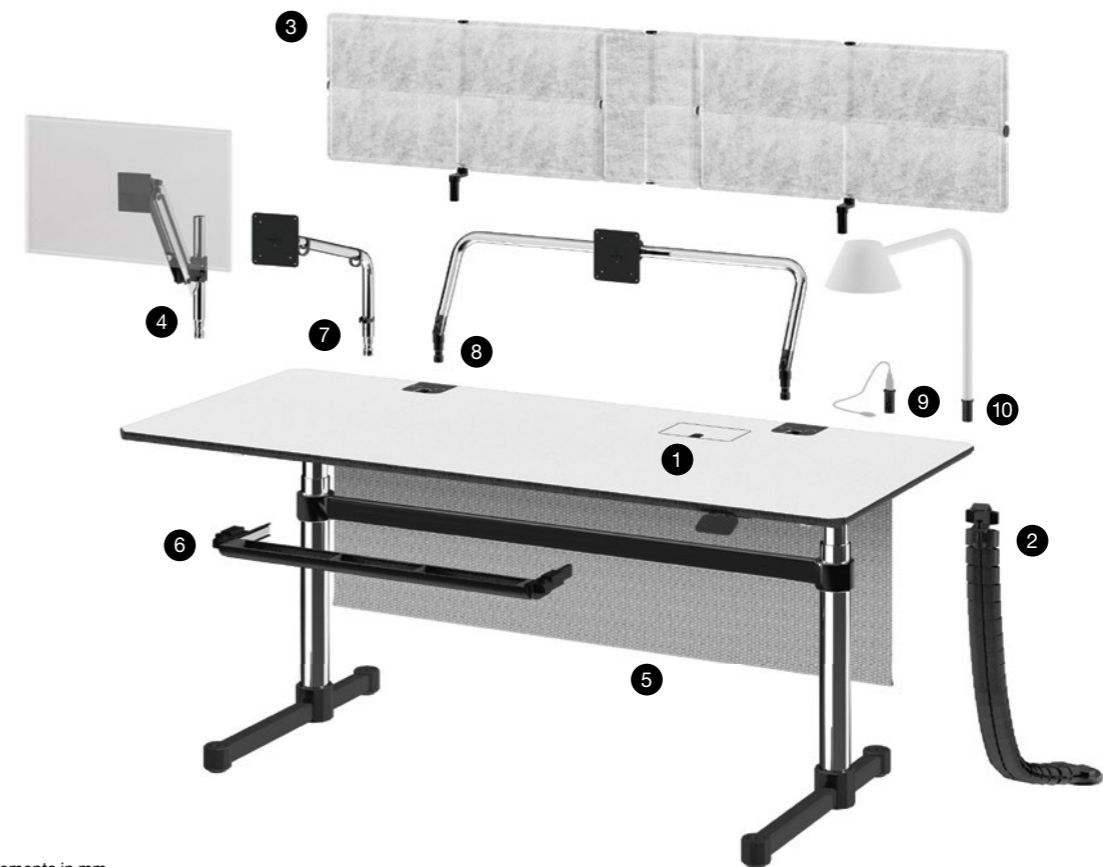

All measurements in mm.

USM Kitos Classic Table

202

203

With free-flow height adjustment, which can be adjusted electronically.

Rectangular



USM Kitos
Rectangular

Electric
height adjustment
H: 700–1200
L: 1800 / D: 900
L: 1750 / D: 750
L: 1500 / D: 750
L: 900 / D: 750

Accessories for all USM Kitos Classic Tables

- 1 Flat screen pivot arm**
Screens are screwed to the height-adjustable pivot arm using a mounting plate (VESA standard). The pivot arm can be mounted onto the tabletop using the universal support. Continuously height-adjustable for screens weighing up to 12 kg.
- 2 USM Privacy Panels**
Fitted on the long side of the table to provide individualisation and privacy.
H: 350 or H: 700.
For tables with lengths: 1800, 1750, 1500.
- 3 Link chain**
Holds and directs cables to the power source. Flexible and adjustable to various lengths.
- 4 Cable wire basket**
For the cable management a cable wire basket can be used. It is hung under the tabletop out of sight.
- 5 Material tray**
Provides room for writing instruments and can be discreetly stowed under the tabletop.



All measurements in mm.

All measurements in mm.

USM Privacy Panels

204

205

Expandable at any time with individual elements, USM Privacy Panels playfully create zones in open spaces and guarantee privacy. Available freestanding or added onto a tabletop.



Modern workspaces

Glass, concrete, open spaces – an architectural dream, but a nightmare for acoustics. USM Privacy Panels help to optimise acoustics in any room.

Room acoustics

Modular zoning

Privacy



USM Privacy Panels

206

207

USM Privacy Panels are a flexible and extendable modular system made up of individual panel units. Each panel unit consists of two layers of molded polyester fabric with a tubular cross-beam. They can be used freestanding or mounted on tables to divide up the workspace, ensure privacy and absorb unwanted noise.

The panels are available in two sizes: a smaller version measuring 250 x 350 mm and a larger version measuring 750 x 350 mm. These dimensions are chosen to match those of the USM Haller system and tables as well as USM Kitos tables. All measurements refer to the distance between axes.

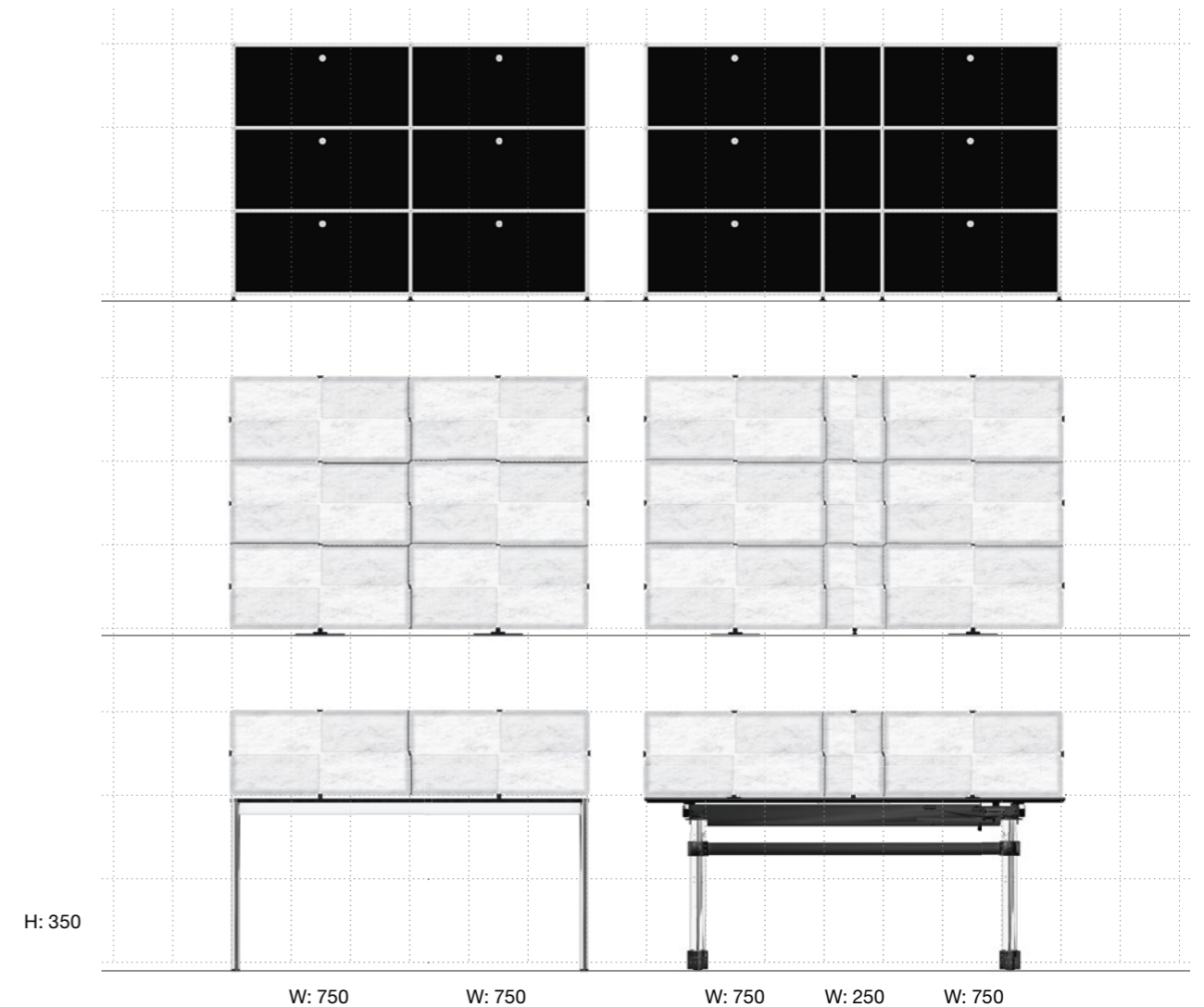
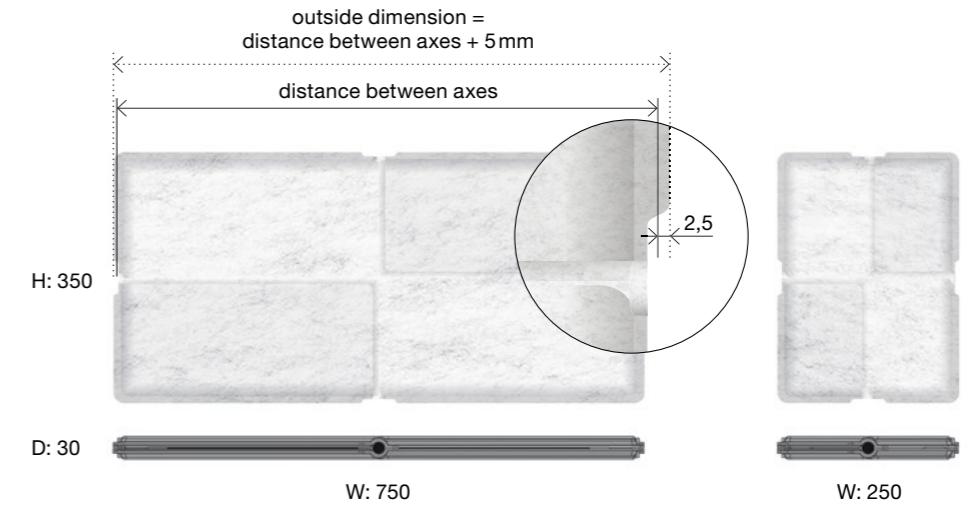

All measurements in mm.

USM Inos box

208

The perfect solution for organising the interior of your USM furniture, compact and stackable.

Interior organisation

Stackable



The USM Inos box is available in four sizes to suit your needs, matching to the dimensions of the USM Haller modular furniture system. The interior can be divided with metal inserts. The boxes and trays are made of polyester fleece, available in two colours.

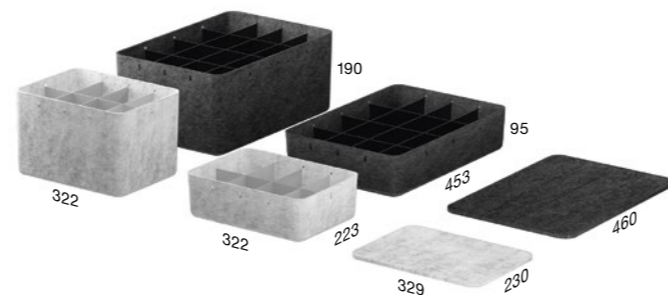

209

USM Inos drawer set

This storage solution fits perfectly into USM Haller furniture to store small items. The choice of colour allows you to add stylish accents to your USM furniture, both inside and out.

Interior organisation



The drawer sets are perfectly matched to the dimensions of the USM Haller modular furniture system. The closed 5 drawer set is available in all 14 USM colours. The open or closed 10 drawer sets and the open 5 drawer sets are available in graphite black and pure white.



Colours & surfaces

USM Haller



Metal

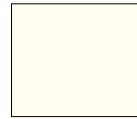

Pure white
RAL 9010



Light grey
RAL 7035



USM mid-grey



Anthracite
RAL 7016



Graphite black
RAL 9011



Golden yellow
RAL 1004



Pure orange
RAL 2004



USM ruby red



Gentian blue
RAL 5010



Steel blue
RAL 5011



USM green



Olive green
RAL 6003



USM beige



USM brown

USM Haller and USM Kitos tables



Laminate



Pearl grey
laminate



Pastel grey
laminate



Light mid-grey
laminate



Dark warm grey
laminate

Powder-coated MDF

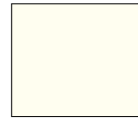

Pure white
RAL 9010

Linoleum



Ash linoleum



Charcoal
linoleum



Black linoleum

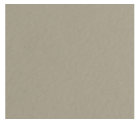

Pebble linoleum



Mauve linoleum

Fenix

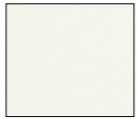

Fenix,
Bianco Kos



Fenix,
Grigio Londra



Fenix,
Nero Ingo

Lacquered veneer



Natural lacquered
oak veneer

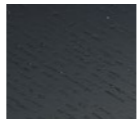

Black lacquered
oak veneer

Other colours and surfaces available upon request.
Prices and delivery times of table surfaces upon request.

USM Haller Soft Panel



Fabric panel

Mono Panel

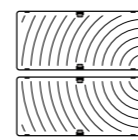
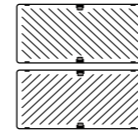

Dark grey



Grey



Taupe

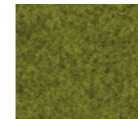

Green



Blue



Red

Duo Panel

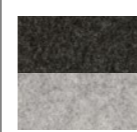
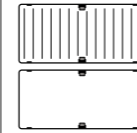

Dark grey
Grey

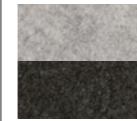

Grey
Dark grey



Taupe
Dark blue



Green
Light green

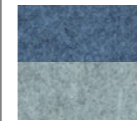

Blue
Light blue



Red
Orange

Mono Panels are designed with the same pattern on both sides (either diagonal or curved grooves) and in a single colour.

Duo Panels have vertical grooves on one side, are plain on the back and available in various colour combinations.

USM Privacy Panels



Fabric panel

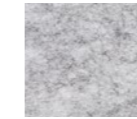

Light grey

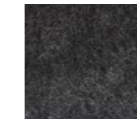

Anthracite

USM Inos box



Fabric panel



Light grey

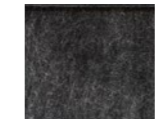

Anthracite

USM Inos drawer set



Metal

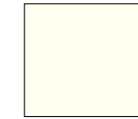

Pure white
RAL 9010



USM mid-grey



Graphite black
RAL 9011



Pure orange
RAL 2004



Gentian blue
RAL 5010



USM green



USM beige



Light grey
RAL 7035



Anthracite
RAL 7016



Golden yellow
RAL 1004



USM ruby red



Steel blue
RAL 5011



Olive green
RAL 6003



USM brown

The following options are available in graphite black and pure white only:
USM Inos drawer set, 5 drawers, open
USM Inos drawer set, 10 drawers, closed
USM Inos drawer set, 10 drawers, open

Pots



Clay



Terracotta



Basalt

- 1 **Sideboard**
W/D/H: 1523/373/740 mm
with four drop-down doors
- 2 **Trolley**
W/D/H: 873/523/978 mm
with two drop-down doors
and one divider shelf
- 3 **Sideboard**
W/D/H: 1523/373/740 mm
with four drop-down doors
- 4 **Sideboard**
W/D/H: 2273/373/740 mm
with two drop-down doors
and one extension door
with metal box insert
- 5 **USM Haller side table**
L/D/H: 750/750/370 mm
Natural lacquered oak
veneer
- 6 **Sideboard**
W/D/H: 1023/1023/540 mm
- 7 **Media unit**
W/D/H: 1523/373/390 mm
with two drop-down doors,
one divider shelf, one cable
cut-out and USM Haller E
lighting*
- 8 **Sideboard**
W/D/H: 2273/523/430 mm
with one extension door
and counterweights
- 9.1 **Sideboard**
W/D/H: 3023/373/915 mm
with four drop-down doors
and four USM Haller Soft
Panels
- 9.2 **Shelving**
W/D/H: 3123/373/2540 mm
with four drop-down doors,
one flip-up door, world of
plants and eight USM Haller
Soft Panels
- 10 **Shelving**
W/D/H: 2023/373/1590 mm
with three drop-down
doors, one flip-up door,
one divider shelf,
world of plants and
USM Haller E lighting*
- 11 **Shelving**
W/D/H: 1523/373/2490 mm
with six drop-down doors,
three extension doors
with metal box insert and
world of plants
- 12 **Glass showcase**
W/D/H: 773/523/1090 mm
with three glass doors
and USM Haller E lighting*
- 13 **Glass showcase**
W/D/H: 3773/373/915 mm
with ten glass doors
and USM Haller E lighting*
- 14 **Kitchen unit**
Price available upon request
- 15 **Bar**
W/D/H: 1773/373/1040 mm
with two drop-down doors
- 16 **USM Haller table**
L/D/H: 1750/750/740 mm
Laminate, pastel grey
- 17 **Serving trolley**
W/D/H: 773/523/575 mm
- 18 **Sideboard**
W/D/H: 1523/723/915 mm
with six drop-down doors
and six extension doors
- 19 **Sideboard**
W/D/H: 2273/373/640 mm
with three drop-down doors
- 20 **Shelving**
W/D/H: 5523/523/2640 mm
with two drop-down doors,
twelve flip-up doors and
twenty extension doors
with ten metal box inserts
- 21 **Shelving**
W/D/H: 773/373/2040 mm
with one drop-down door,
one extension door
with metal box insert
and counterweights
- 22.1 **USM Haller table**
L/D/H: 2000/1000/740 mm
Fenix, Nero Ingo
- 22.2 **Showcase**
W/D/H: 2523/373/1865 mm
with four extension doors,
eight glass doors and
USM Haller E lighting*
- 23 **Kitchen trolley**
W/D/H: 773/523/675 mm
with world of plants
- 24.1 **Shelving**
W/D/H: 2123/373/1315 mm
with three drop-down doors,
three extension doors
with metal box inserts and
two glass doors
- 24.2 **USM Haller table**
L/D/H: 2000/1000/740 mm
Linoleum, Nero
- 25 **Trolley**
W/D/H: 1023/523/1030 mm
with one drop-down door
and two extension doors
with metal box inserts
- 26 **Sideboard**
W/D/H: 1523/373/990 mm
with four drop-down doors
- 27 **Sideboard**
W/D/H: 1523/373/1090 mm
with two angled shelves,
four bookshelf panels and
USM Haller E lighting*
- 28 **Shelving**
W/D/H: 3123/373/1765 mm
with seven drop-down
doors, three extension
doors with metal box
inserts, two divider shelves
and world of plants
- 29 **Side table**
W/D/H: 773/373/565 mm
with one drop-down door
- 30 **Low media unit**
W/D/H: 1523/373/430 mm
with two drop-down doors
- 31 **Low mobile
TV/HiFi unit**
W/D/H: 1523/373/430 mm
with two extension doors
with metal box inserts
and counterweights
- 32 **Low media unit**
W/D/H: 2273/523/390 mm
with two drop-down doors,
one flip-up door and
one divider shelf
- 33 **Trolley**
W/D/H: 723/373/675
- 34 **Sideboard**
W/D/H: 1123/523/740 mm
with one drop-down door
- 35 **Media unit**
W/D/H: 3373/373/1440 mm
one drop-down door,
four extension doors,
world of plants, two
USM Haller Soft Panels
and USM Haller E lighting*
- 36 **USM Inos Boxes**
W/D/H: deep, 250 mm,
tall, 250 mm with tray
- 37 **Sideboard**
W/D/H: 1523/523/565 mm
with two drop-down doors
- 38 **Low media unit**
W/D/H: 3023/523/430 mm
with four drop-down doors
- 39 **Hi-Fi unit**
W/D/H: 2023/523/990 mm
with four extension shelves
with filing frames, one drop-
down door, one divider shelf
and counterweights
- 40 **Sideboard**
W/D/H: 2273/373/740 mm
with three extension doors
- 41 **Shelving**
W/D/H: 2973/373/1965 mm
with four drop-down doors,
two flip-up doors,
four extension doors
with one metal box insert
and cable cut-out
- 42 **Bed**
W/D/H: 3773/2198/1340 mm
with two drop-down doors
- 43 **Sideboard**
W/D/H: 1023/373/965 mm
with one extension door
with metal box insert and
two divider shelves
- 44 **Wardrobe**
W/D/H: 773/373/1915 mm
with two extension doors
with metal box insert

- 45 **Side table**
W/D/H: 773/373/840 mm
with two drop-down doors
- 46 **Side table**
W/D/H: 523/373/565 mm
with one drop-down door
- 47 **Storage unit**
W/D/H: 1523/523/915 mm
with six extension doors
and four drawers
- 48 **Storage unit**
W/D/H: 1873/373/390 mm
with three drop-down doors
- 49 **Storage unit**
W/D/H: 773/525/1265 mm
with one extension door,
two drop-down doors and
two drawers
- 50 **Side unit**
W/D/H: 523/373/590 mm
with two drop-down doors
- 51 **Side table**
W/D/H: 523/373/565 mm
with one drop-down door
- 52 **Sideboard**
W/D/H: 1523/373/540 mm
with two drop-down doors
- 53 **Shelving**
W/D/H: 1623/373/1440 mm
with two drop-down doors,
world of plants, two
USM Haller Soft Panels
and USM Haller E lighting*
- 54 **Sideboard**
W/D/H: 773/373/740 mm
with one drop-down door
- 55 **Trolley**
W/D/H: 1023/523/1030 mm
with one drop-down door,
one extension door with
metal box insert and
one extension shelf with
metal box insert
- 56 **Desk with toy box**
W/D/H: 1273/523/580 mm
- 57 **Storage unit**
W/D/H: 1523/373/1090 mm
with four drop-down doors
- 58 **Low storage unit**
W/D/H: 2023/373/390 mm
with four drop-down doors
- 59 **Shelving**
W/D/H: 3273/373/2140 mm
with ten drop-down doors
- 60 **Sideboard**
W/D/H: 1523/523/990 mm
with nine extension doors
with metal box inserts
- 61 **Side table**
W/D/H: 523/373/565 mm
with one drop-down door
- 62 **Toy box**
W/D/H: 373/373/390 mm

- 63 **Shelving**
W/D/H: 2273/723/740 mm
with one drop-down door,
five extension shelves
with two metal box inserts
and one divider shelf
- 64 **Toy box**
W/D/H: 523/523/430 mm
- 65 **Shelving**
W/D/H: 1168/373/2140 mm
with four USM Haller Soft
Panels
- 66 **Shelving**
W/D/H: 3723/373/1590 mm
with eight drop-down doors,
two extension doors,
two extension doors with
metal box inserts, two
flip-up doors, one extension
shelf with metal box insert,
two glass doors, two divider
shelves and USM Haller E
lighting*
- 67 **Shelving**
W/D/H: 3023/373/2140 mm
with one drop-down door
- 68 **Shelving**
W/D/H: 3523/373/1790 mm
with ten drop-down doors
- 69 **Shelving**
W/D/H: 3773/373/2140 mm
- 70 **Shelving**
W/D/H: 1418/373/2915 mm
with four drop-down doors
and two USM Haller Soft
Panels
- 71 **Shelving**
W/D/H: 1523/373/2215 mm
with four drop-down doors,
three extension doors
with metal box inserts,
one flip-up door
and USM Haller E lighting*
- 72 **Shelving**
W/D/H: 1273/373/1440 mm
with two drop-down doors
with USM Haller lock C and
four USM Haller Soft Panels
- 73 **Shelving**
W/D/H: 2273/373/1440 mm
with three drop-down doors
and three extension doors
- 74 **Shelving**
W/D/H: 3273/373/1965 mm
with three drop-down doors
and one flip-up door
- 75 **Shelving**
W/D/H: 523/373/1590 mm
with two drop-down doors
and one extension door with
metal box insert
- 76 **Shelving**
W/D/H: 1023/373/1765 mm
with two drop-down doors,
two extension doors
with metal box inserts,
one flip-up door, two glass
doors, one divider shelf
and USM Haller E lighting*
- 77 **Sideboard**
W/D/H: 1523/373/890 mm
with two extension doors
and counterweights
- 78 **Shelving**
W/D/H: 773/373/1090 mm
with three drop-down doors
- 79 **Glass showcase**
W/D/H: 1023/373/1340 mm
with two drop-down doors
and two glass doors
- 80 **Mobile pedestal**
W/D/H: 523/373/605 mm
with three extension doors
with one metal box insert
and counterweights
- 81 **Mobile pedestal**
W/D/H: 773/523/755 mm
with one drop-down door,
two extension doors
with one metal box insert
and counterweights
- 82 **Sideboard**
W/D/H: 1523/373/978 mm
with two drop-down doors,
one divider shelf
and one cable cut-out
- 83 **Sideboard**
W/D/H: 1523/373/740 mm
with four USM Haller Soft
Panels
- 84 **Shelving**
W/D/H: 1023/373/815 mm
with two drop-down doors
- 85 **Side unit**
W/D/H: 773/373/565 mm
with one drop-down door
- 86 **Shelving**
W/D/H: 523/373/1790 mm
with three USM Haller Soft
Panels
- 87 **Shelving**
W/D/H: 2023/373/1870 mm
with five drop-down doors,
three extension doors
with metal box inserts and
world of plants
- 88 **Sideboard**
W/D/H: 2023/373/990 mm
with three drop-down
doors, one divider shelf,
one extension shelf
and world of plants
- 89 **Desk**
W/D/H: 1123/523/1790 mm
with two drop-down doors
- 90 **Shelving**
W/D/H: 1523/373/1090 mm
with four extension doors
with filing frames
- 91 **Shelving**
W/D/H: 3523/373/1790 mm
with thirteen drop-down
doors
- 92 **USM Haller table**
L/D/H: 1500/750/740 mm
Laminate, pearl grey
- 93 **Mobile pedestal**
W/D/H: 1023/373/605 mm
with four drop-down doors
- 94 **Desk**
W/D/H: 2623/523/1090 mm
with three drop-down doors
and one extension shelf
- 95.1 **Trolley**
W/D/H: 773/373/780 mm
with one drop-down door
and one extension shelf
- 95.2 **USM Haller table**
L/D/H: 1500/750/740
Linoleum, Nero
- 95.3 **Rolling pedestal**
W/D/H: 418/523/605 mm
with three drawers and
counterweights
- 95.4 **Shelving**
W/D/H: 1024/373/1590 mm
with four drop-down doors
and six glass doors
- 96.1 **USM Haller table**
L/D/H: 1750/750/740 mm
Linoleum, Charcoal
- 96.2 **Rolling pedestal**
W/D/H: 418/523/605
with two drawers and
counterweights
- 97 **Desk**
W/D/H: 1168/523/740 mm
with one drop-down door
- 98 **Shelving**
W/D/H: 773/373/1090 mm
with three drop-down doors
- 99 **Rolling pedestal**
W/D/H: 418/523/605 mm
with two drawers and
counterweights
- 100 **Shelving**
W/D/H: 773/373/1790 mm
with two drop-down doors,
one divider shelf,
one extension door with
metal box insert and
one USM Haller Soft Panel
- 101.1 **Shelving**
W/D/H: 2023/373/2390 mm
with three drop-down
doors, two glass doors
and world of plants
- 101.2 **USM Kitos M**
L/D/H:
1800/900/700–1200 mm
Linoleum, Pebble
- 101.3 **Mobile pedestal**
W/D/H: 418/523/605 mm
with three drawers
and counterweights



Price list

Scan the QR code to go
to the price list.

* with a dimmable cold or warm white light

- 102.1 **Reception**
W/D/H: 2973/1873/1690 mm
with one angled shelf
- 102.2 **USM Haller table**
L/D/H: 2250/750/740 mm
Laminate, pastel grey
- 103.1 **Reception**
W/D/H: 2268/1123/990 mm
with two extension doors
with metal box inserts and
three cable cut-outs
- 103.2 **USM Haller table**
L/D/H: 3000/750/740 mm
Laminate, pearl grey
- 104 **Barrier-free reception**
W/D/H: 3023/773/1090 mm
with one drop-down door,
two drawers A6,
one extension shelf and
three angled shelves
- 105.1 **Sideboard**
W/D/H: 2523/373/740 mm
with three drop-down doors,
one glass door, two angled
shelves and world of plants
- 105.2 **USM Haller side table**
L/D/H: 773/523/390 mm
- 106 **Sideboard/Cloakroom**
W/D/H: 3023/873/1790 mm
with five drop-down doors
- 107 **Counter**
W/D/H: 2523/873/1090 mm
with one drop-down door,
one extension shelf
and one angled shelf
- 108 **Reception**
W/D/H: 4873/1773/1090 mm
with two extension doors
with filing frame, four exten-
sion shelves, four drawers
and two glass doors
- 109 **USM Haller side table**
W/D/H: 523/523/390 mm
- 110 **Shelving**
W/D/H: 3373/1073/2490 mm
with eight drop-down doors,
four angled shelves,
one divider shelf
and a world of plants
- 111.1 **Shelving**
W/D/H: 3773/373/2440 mm
with eight drop-down doors
and world of plants
- 111.2 **USM Haller Advanced
table**
L/D/H: 2000/1000/740 mm
with flat screen support arm
Linoleum, Mauve
- 111.3 **Mobile pedestal**
W/D/H: 418/523/605 mm
with three drawers
and counterweights
- 111.4 **Sideboard**
W/D/H: 3023/373/740 mm
with two drop-down doors
and two extension doors
- 112.1 **USM Haller table**
L/D/H: 2000/750/740
Linoleum, Pebble
- 112.2 **Sideboard**
W/D/H: 773/373/740 mm
with one drop-down door,
one divider shelf and
one extension door with
metal box insert
- 113.1 **USM Haller table**
L/D/H: 3000/750/740 mm
with USM Privacy Panels
Linoleum, Charcoal
- 113.2 **Shelving**
W/D/H: 773/373/1340 mm
with two drop-down doors
and world of plants
- 114.1 **Shelving**
W/D/H: 1773/418/2140 mm
with one drop-down door,
one extension door with
metal box insert and
two extension shelves with
one metal box insert
- 114.2 **USM Kitos M Plus
table**
L/D/H:
1750/750/700–1200 mm
Linoleum, Pebble
- 115.1 **Shelving**
W/D/H: 773/373/1790 mm
with one extension door
with metal box insert,
three drop-down doors
and one flip-up door
- 115.2 **USM Kitos M Plus**
L/D/H:
1750/750/700–1200 mm
with USB A adapter
Linoleum, Nero
- 116.1 **USM Haller Plus table**
L/D/H: 1750/750/740 mm
Natural lacquered oak
veneer
- 116.2 **Storage**
W/D/H: 1523/373/915 mm
with two extension doors,
four extension shelves,
lock C and world of plants
- 117.1 **Z unit**
W/D/H: 3623/1473/1440 mm
with eight drop-down doors,
one divider shelf,
world of plants and eleven
USM Haller Soft Panels
- 117.2 **USM Kitos M Plus**
L/D/H:
1800/900/700–1200 mm
Laminate, pearl grey
- 118.1 **Sideboard**
W/D/H: 2273/373/1340 mm
with nine drop-down doors
- 118.2 **USM Haller table**
L/D/H: 1750/750/740 mm
MDF, powder coated
- 118.3 **Rolling pedestal**
W/D/H: 418/523/605 mm
with three drawers
and counterweights
- 118.4 **Sideboard**
W/D/H: 3773/373/990 mm
with ten drop-down doors
- 119 **USM Kitos M Plus**
L/D/H:
1750/750/700–1200 mm
MDF, powder coated
- 120 **USM Haller Plus table**
L/D/H: 3000/750/740 mm
with two adjustable flat
screen support bars,
two USB C adapter and
two cable grids
Laminate, pearl grey
- 121.1 **Shelving**
W/D/H: 6023/723/2665 mm
with six drop-down doors,
seven extension doors
with metal box inserts and
four USM Haller Soft Panels
- 121.2 **USM Kitos M Plus**
L/D/H:
1750/750/700–1200 mm
Linoleum, Nero
- 122 **Sideboard**
W/D/H: 3023/373/1090 mm
with nine drop-down doors,
acoustically effective
- 123 **Shelving**
W/D/H: 3023/1873/1485 mm
with five drop-down doors
and world of plants
- 124.1 **USM Haller table**
L/D/H: 2000/1000/740 mm
Fenix, Grigio Londra
- 124.2 **Shelving**
W/D/H: 4523/523/1790 mm
with world of plants
- 124.3 **USM Haller Plus table**
L/D/H: 3000/750/740 mm
with USM Privacy Panels
Fenix, Grigio Londra
- 124.4 **Shelving**
W/D/H: 4523/373/1440 mm
with ten drop-down doors
- 125.1 **USM Privacy Panels**
W/D/H: 2250/1500/1440 mm
- 125.2 **Caddy**
W/D/H: 523/523/1130 mm
with two drop-down doors
- 125.3 **USM Haller table**
L/D/H: 2000/1000/740 mm
Fenix, Grigio Londra

- 126.1 **Bench with storage**
W/D/H: 5273/723/740 mm
with three drop-down doors
- 126.2 **USM Haller table**
L/D/H: 3000/1000/370 mm
Laminate, pastel grey
- 127 **USM Kitos M Plus**
L/D/H:
1750/750/700–1200 mm
Linoleum, Ash
- 128.1 **USM Haller Plus table**
L/D/H: 3000/750/740 mm
with two grommet hatches
and two cable grids
Linoleum, Ash
- 128.2 **Mobile pedestal**
W/D/H: 418/523/530 mm
with three drawers and
counterweights
- 128.3 **Shelving**
W/D/H: 1523/723/740 mm
with two extension doors
- 129.1 **USM Privacy Panels**
W/D/H: 3750/2250/1440 mm
- 129.2 **USM Haller Plus table**
L/D/H: 3000/750/740 mm
with one USB A Adapter
Laminate, pearl grey
- 130 **USM Haller table**
L/D/H: 2000/1000/740 mm
Fenix, Nero Ingo
- 131.1 **USM Haller table**
L/D/H: 1500/750/740 mm
Fenix, Nero Ingo
- 131.2 **Sideboard**
W/D/H: 5273/723/740 mm
with four drop-down doors
- 132 **Serving trolley**
W/D/H: 1023/523/960 mm
with one extension door
with metal box insert,
two divider shelves and
two cable cut-outs
- 133 **Snack bar**
W/D/H: 3773/373/2365 mm
with five drop-down doors
and four extension doors
with metal box inserts
- 134.1 **Trolley**
W/D/H: 523/523/705 mm
- 134.2 **USM Kitos E**
L/D/H:
1750/750/650–1300 mm
Natural lacquered oak
veneer
- 134.3 **Sideboard**
W/D/H: 3023/523/1190 mm
with five drop-down doors,
four extension doors
with metal box inserts
and sixteen drawers

- 135 **USM Kitos M
Meeting table**
L/D/H:
2250/1000/700–1150 mm
with two grommet hatches
Linoleum, Pebble
- 136.1 **USM Haller table**
L/D/H: 1500/750/740 mm
Linoleum, Nero
- 136.2 **Sideboard**
W/D/H: 3773/373/740 mm
with ten drop-down doors
- 137.1 **Shelving**
W/D/H: 3773/373/1440 mm
with two drop-down doors
and four flip-up doors
- 137.2 **USM Kitos M
Meeting table**
L/D/H:
2500/1000/700–1150 mm
Natural lacquered oak
veneer
- 137.3 **Caddy**
W/D/H: 523/373/1030 mm
with two drop-down doors
and counterweights
- 138.1 **USM Haller table**
L/D/H: 3000/1000/740 mm
Natural lacquered oak
veneer
- 138.2 **Shelving**
W/D/H: 1523/373/640 mm
with six drop-down doors
- 139 **USM Kitos M
Meeting table**
L/D/H:
2250/1000/700–1150 mm
Laminate, pearl grey
- 140.1 **Serving trolley**
W/D/H: 773/523/575 mm
- 140.2 **Sideboard**
W/D/H: 2523/373/740 mm
with four drop-down doors
- 140.3 **USM Kitos M
Meeting table**
L/D/H:
2500/1000/700–1150 mm
with two grommet hatches
Laminate, dark warm grey
- 141.1 **Shelving**
W/D/H: 6123/723/2815 mm
This piece contains special
parts, our sales partners
will be happy to advise you.
- 141.2 **USM Haller table**
L/D/H: 750/750/740 mm
Linoleum, Nero
- 142 **USM Haller table**
L/D/H: 2000/1000/740 mm
Laminate, pearl grey
- 143.1 **USM Kitos M
Meeting table**
L/D/H:
2500/1000/700–1150 mm
with two grommet hatches
Fenix, Nero Ingo
- 143.2 **Shelving on castors**
W/D/H: 1873/768/1480 mm
with two acoustic
drop-down doors and
world of plants
- 144 **USM Kitos
Freestanding**
L/D/H:
750/750/700–1110 mm
Laminate, pearl grey
- 145 **USM Kitos
Freestanding**
L/D/H:
900/900/700–1110 mm
Laminate, pearl grey
- 146 **Shelving**
W/D/H: 4523/373/1440 mm
with six drop-down doors
and twelve angled shelves
- 147 **Shelving**
W/D/H: 2023/548/1740 mm
with two drop-down doors
- 148 **Mobile Storage**
W/D/H: 1473/373/1130 mm
with six drop-down doors
- 149 **Shelving**
W/D/H: 3023/723/1940 mm
with four extension doors
with filing frames,
two flip-up doors and
seven bookshelf panels
- 150 **Shelving**
W/D/H: 5273/373/2185 mm
with seven drop-down doors
- 151 **Shelving**
W/D/H: 2273/1523/2490 mm
with fourteen drop-down
doors and world of plants
- 152 **Trolley**
W/D/H: 523/373/1030 mm
with two drop-down doors
- 153 **Trolley**
W/D/H: 523/373/780 mm
with one drop-down door
- 154.1 **Lockers**
W/D/H: 3523/373/535 mm
with seven drop-down doors
and reinforcing profiles
- 154.2 **Lockers**
W/D/H: 4023/373/535 mm
with eight drop-down doors
and reinforcing profiles



Price list

Scan the QR code to go
to the price list.

Switzerland

USM U. Schärer Söhne AG
Thunstrasse 55, 3110 Münsingen
Phone +41 31 720 72 72, info.ch@usm.com

Germany

USM U. Schärer Söhne GmbH
Siemensstrasse 4a, 77815 Bühl
Phone +49 7223 80 94 0, info.de@usm.com

France

USM U. Schaerer Fils SA, Paris Showroom
23, rue de Bourgogne, 75007 Paris
Phone +33 1 53 59 30 37, info.fr@usm.com

United Kingdom

USM U. Schaerer Sons Ltd., London Showroom
Marylebone Square, 12 Cramer Street
London W1U 4EA
Phone +44 207 183 3470, info.uk@usm.com

USA

USM U. Schaerer Sons Inc., New York Showroom
28-30 Greene Street, New York, NY 10013
Phone +1 212 371 1230, info.us@usm.com

Japan

USM U. Schaerer Sons K.K., Tokyo Showroom
Meiji Yasuda Seimei Building 1-2F
2-1-1 Marunouchi, Chiyoda-ku, Tokyo 100-0005
Phone +81 3 6635 9420, info.jp@usm.com

China

USM Trading (Shanghai) Co. Ltd., Shanghai Showroom
Building C, 2F, Room 201, No. 12 Yongyuan Road
Jing'an District, Shanghai 200040
Phone +86 189 3977 2732, info.cn@usm.com

All other countries

contact USM Switzerland.



Our lived realities are in a constant state of change – shaped by new challenges, evolving work cultures and a lifestyle that continues to develop over time. At the same time, the boundaries between living and working are increasingly dissolving – as is the clear distinction between specifically and hybrid-used public and semi-public spaces.

USM has been responding to this dynamic for over 60 years, playfully, with a modular furniture system that can be precisely tailored to personal style, individual needs and spatial conditions – right from the design phase – and can evolve over generations.

This open system inspires highly individual solutions – as playful, versatile and unique as the people who use them. From compact design classics for everyday use to multi-functional spatial elements for hybrid environments.

Crafted in outstanding Swiss quality, USM stands for enduring, value-driven companions through change – whether at home, at the office or somewhere beyond.

*Design
your own*