

USM Haller

Le système USM Haller propose un grand nombre d'éléments en tailles standard. Largeurs, profondeurs et hauteurs sont disponibles comme ci-dessous. Toutes les dimensions sont données à l'entraxe des boules.

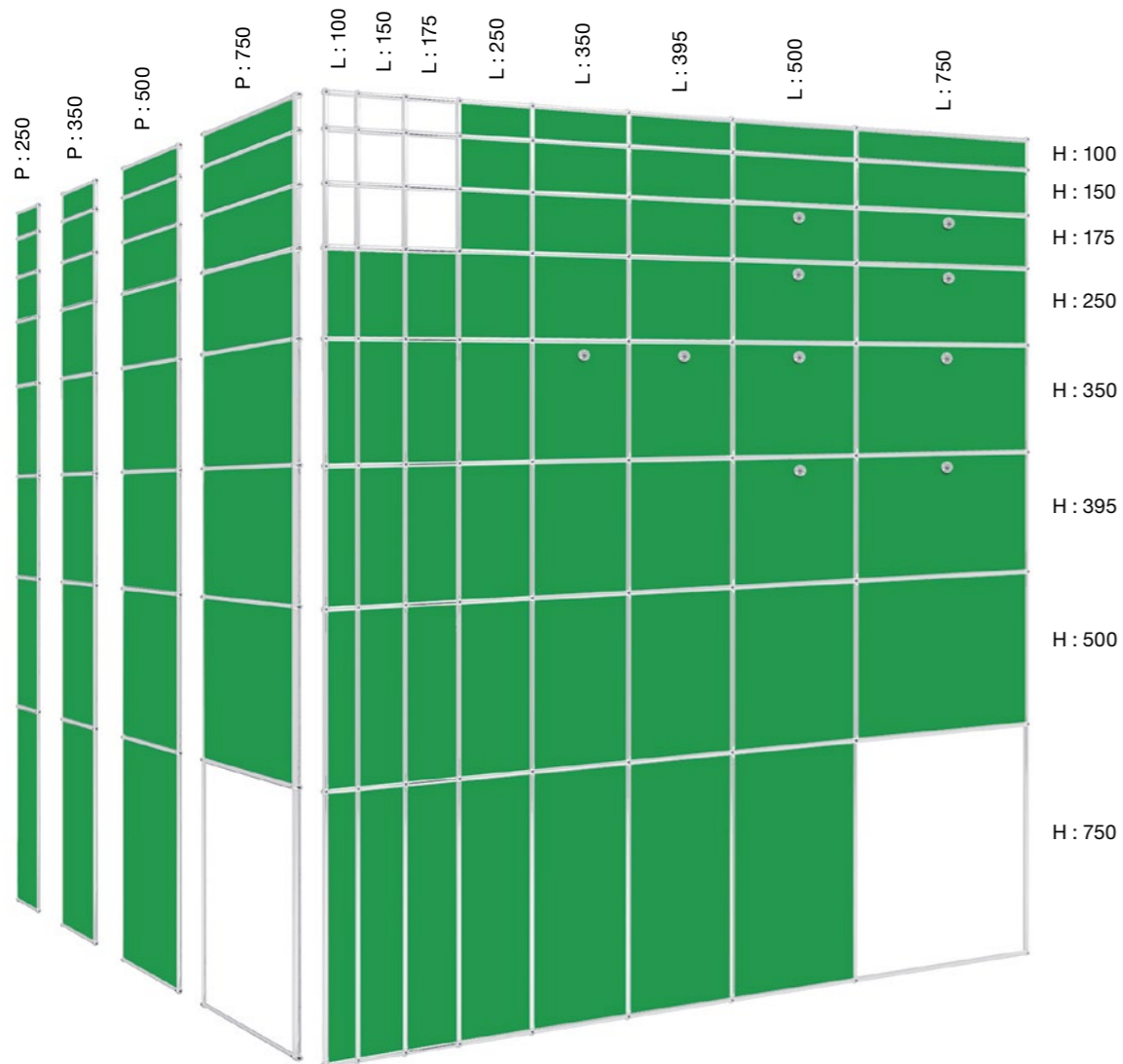

Votre sécurité est une priorité. Consultez les consignes de sécurité USM. www.usm.com/safety

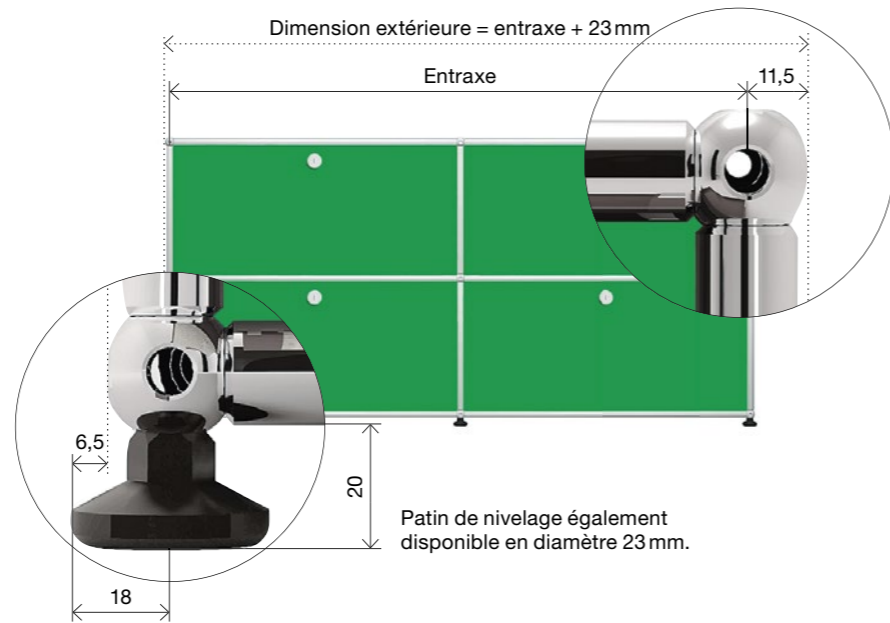

Toutes les dimensions sont en mm.

Eléments Portes Tablettes et tiroirs Accessoires

- | | | | | |
|-----------------------------|---------------------------------|---|--|--|
| 1 Paroi métallique | 5 Porte escamotable métallique* | 10 Tablette intermédiaire métallique | 20 Panier pour dossiers suspendus | 27 USM Inos Trieur |
| 2 Paroi en verre | 6 Porte en verre | 11 Tablette intermédiaire en verre | 21 Cadre de réhausse | 28 Serre-livres pour éléments métalliques avec butée arrière (P:350) |
| 3 Paroi perforée acoustique | 7 Porte perforée acoustique | 12 Rayon coulissant métallique | 21a Profil support de dossiers suspendus | 29 USM Inos, boîte à tiroirs, façade ouverte |
| 4 Paroi perforée | 8 Porte abattante métallique | 13 Tablette métallique inclinée | 22 Découpe pour câbles | 30 USM Inos, boîte à tiroirs, façade fermée |
| | 9 Porte coulissante métallique* | 14 Panier de classement sur un rayon coulissant | 23 Serre-livres, équerres magnétiques | 31 USM Inos Kit d'équipement |
| | | 15 Tiroir A7 P: 500 | 24 USM Inos Box | |
| | | 16 Tiroir A6 P: 500 | 25 USM Inos Range DVD | |
| | | 17 Tiroir A5 P: 500 | 26 USM Inos Range CD | |
| | | 18 Tiroir A4 P: 500 | | |
| | | 19 Panneau de l'univers végétal avec évidement circulaire pour insérer un ou plusieurs pots | | |

Configurez votre propre meuble USM Haller ! www.usm.com



*Existe en version à effet acoustique.

Meuble présenté en profondeur 500 mm. Toutes les dimensions sont en mm.

Plateaux de table et couleurs

Meubles USM Haller



Métal

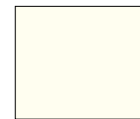

Blanc pur
RAL 9010



Gris clair
RAL 7035



Gris moyen USM



Anthracite
RAL 7016



Noir graphite
RAL 9011



Jaune or
RAL 1004



Orange pur
RAL 2004



Rouge rubis
USM



Bleu gentiane
RAL 5010



Bleu acier
RAL 5011



Vert USM



Vert olive
RAL 6003



Beige USM



Marron USM

Bureaux USM Haller et USM Kitos



Stratifié



Stratifié
gris perle



Stratifié
gris clair



Stratifié
gris moyen



Stratifié
gris foncé

MDF thermo-laqué

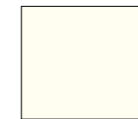

Blanc pur
RAL 9010

Linoléum

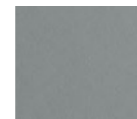

Linoléum
Ash



Linoléum
Charcoal

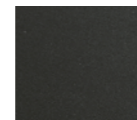

Linoléum
Nero

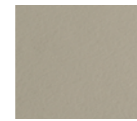

Linoléum
Pebble



Linoléum
Mauve

Fenix



Fenix,
Bianco Kos



Fenix,
Grigio Londra



Fenix,
Nero Ingo

Placage bois

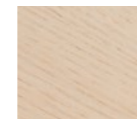

Plaqué chêne
blanc huilé

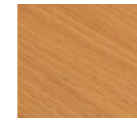

Plaqué chêne
naturel huilé



Plaqué chêne
naturel vernis

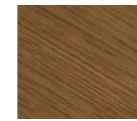

Plaqué chêne
marron huilé

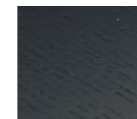

Plaqué chêne
noir vernis



Plaqué hêtre
naturel vernis

Verre transparent



Verre transparent

USM Privacy Panels



Polyester moulé

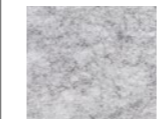

Gris clair

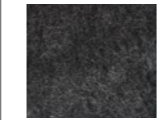

Anthracite

USM Inos Box



Polyester moulé



Gris clair

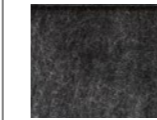

Anthracite

USM Inos boîte à tiroirs



Métal

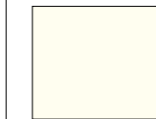

Blanc pur
RAL 9010



Gris moyen USM



Noir graphite
RAL 9011



Orange pur
RAL 2004



Bleu gentiane
RAL 5010



Vert USM



Beige USM



Gris clair
RAL 7035



Anthracite
RAL 7016



Jaune or
RAL 1004



Rouge rubis
USM



Bleu acier
RAL 5011



Vert olive
RAL 6003



Marron USM

Pots



Terre cuite



Terracotta

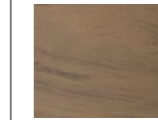

Basalt

Détails

Meubles USM Haller



Métal

Bureaux USM Haller

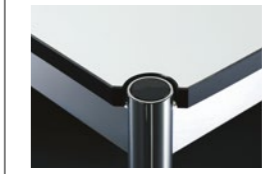

Stratifié

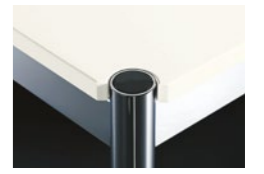

MDF thermo-laqué

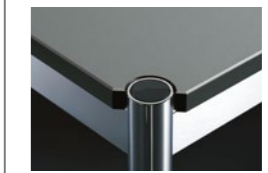

Linoléum

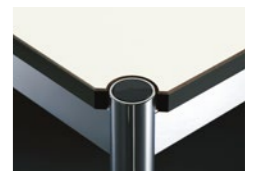

Fenix



Placage bois

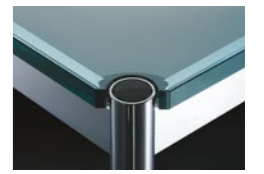

Verre transparent

Bureaux USM Kitos



Stratifié



MDF thermo-laqué

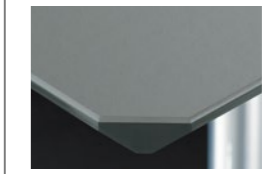

Linoléum



Fenix

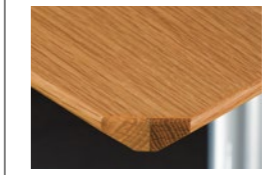

Placage bois

Le plateau en verre est disponible uniquement pour les tables USM Haller jusqu'à L: 2000mm.
Autres plateaux de table et couleurs sur demande.
Prix et délai de livraison des finitions de tables sur demande.

Les options suivantes sont uniquement disponibles en noir graphite et blanc pur :
USM Inos boîte à tiroirs avec 5 tiroirs, ouverts
USM Inos boîte à tiroirs avec 10 tiroirs, fermés
USM Inos boîte à tiroirs avec 10 tiroirs, ouverts