

USM Haller table

The USM Haller and USM Haller Plus desk can be equipped with an optional cable basket, while the USM Haller Advanced features integrated smart solutions for electrification. All desks can be equipped with grommet hatches for network access.

Basic table

Optional cable basket underneath the tabletop



USM Haller

H: 740
L: 3000 / D: 1000
L: 3000 / D: 750
L: 2500 / D: 1000
L: 2500 / D: 750
L: 2250 / D: 1000
L: 2250 / D: 750
L: 2000 / D: 1000
L: 2000 / D: 750
L: 1750 / D: 1000
L: 1750 / D: 750
L: 1500 / D: 1000
L: 1500 / D: 750
L: 1250 / D: 1000
L: 1250 / D: 500*
L: 1000 / D: 1000
L: 750 / D: 750

Sliding tabletop + adaptation points

Integrated cable tray accessible from above by sliding back the tabletop
Adaptation points for accessories



USM Haller Advanced

H: 740
L: 2000 / D: 1000
L: 2000 / D: 750
L: 1750 / D: 1000
L: 1750 / D: 750
L: 1500 / D: 1000
L: 1500 / D: 750
L: 1250 / D: 750

Working desk

Optional cable basket underneath the tabletop
Removable adaptation points for accessories



USM Haller Plus

H: 740
L: 3000 / D: 1000
L: 3000 / D: 750
L: 2000 / D: 1000
L: 2000 / D: 750
L: 1750 / D: 1000
L: 1750 / D: 750
L: 1500 / D: 1000
L: 1500 / D: 750
L: 1250 / D: 750

Side table



USM Haller Side table

H: 370
L: 3000 / D: 1000
L: 3000 / D: 750
L: 2500 / D: 1000
L: 2500 / D: 750
L: 2250 / D: 1000
L: 2250 / D: 750
L: 2000 / D: 1000
L: 2000 / D: 750
L: 1750 / D: 1000
L: 1750 / D: 750
L: 1500 / D: 1000
L: 1500 / D: 750
L: 1250 / D: 1000
L: 1000 / D: 1000
L: 750 / D: 750

Accessories for all USM Haller desks

- 1 **Grommet hatch for network access**
Hatch for a single power outlet, flushmounted in tabletop. This unit can be mounted in two different positions on the tabletop.
- 2 **Cable management**
For the USM Haller Advanced table, a cable tray integrated under the tabletop offers storage room and attachment options for all cables and technical components. For the USM Haller and USM Haller Plus table, a cable wire basket can be attached.
- 3 **CPU holder**
Computers in various sizes can be mounted using a simple holding device under the table.
- 4 **Cable guide**
Is clamped to the table legs and guides cables to their outlets.
- 5 **Link chain**
Holds and directs cables to the power source. Flexible and adjustable to different lengths.
- 6 **Flat screen support arm**
Screens are mounted onto the support arm (VESA standard). Swivel-type with a spherical joint for the screen. Mounting at different heights is possible for screens weighing up to 12 kg.
- 7 **Flat screen pivot arm**
Screens are screwed to the height adjustable pivot arm using a mounting plate (VESA standard). Continuous height adjustment for screens weighing up to 12 kg.
- 8 **Front and side panel**
Can be attached under the table to the long side or laterally. For tables with lengths: 2000, 1750, 1500, 1250 and depths: 1000, 750.
- 9 **Pivoting pen holder**
Provides room for writing instruments and can be discreetly stowed under the tabletop.
- 10 **USM Privacy Panels**
Fitted on the long side of the table to provide individualisation and privacy. H: 350 or H: 700. For tables with lengths: 3000, 2000, 1750, 1500.

Accessories for USM Haller Plus / Advanced desk

- 11 **Flat screen support bar**
The support bar is inserted into the adaptation points. Up to two screens (max. 2 x 12 kg) can be attached using a mounting plate (VESA standard). Screens can be mounted at different heights; screens can be adjusted with ball joints. Continuously height-adjustable for screens weighing up to 12 kg.
 - 12 **USB adapter**
The adapter can be used for USB A 3.0 and C connections. It can easily be inserted into the adaptation point. Usable as power supply or for data transfer.
 - 13 **Lamp peg**
An optional lamp peg for easy attachment of selected table lamps. Electrification is possible through the adaptation point.
- Options
- 11a **Flat screen support bar fix**
 - 11b **Flat screen support bar adjustable**
Move forwards or backwards two notches at a time to adjust the viewing distance.

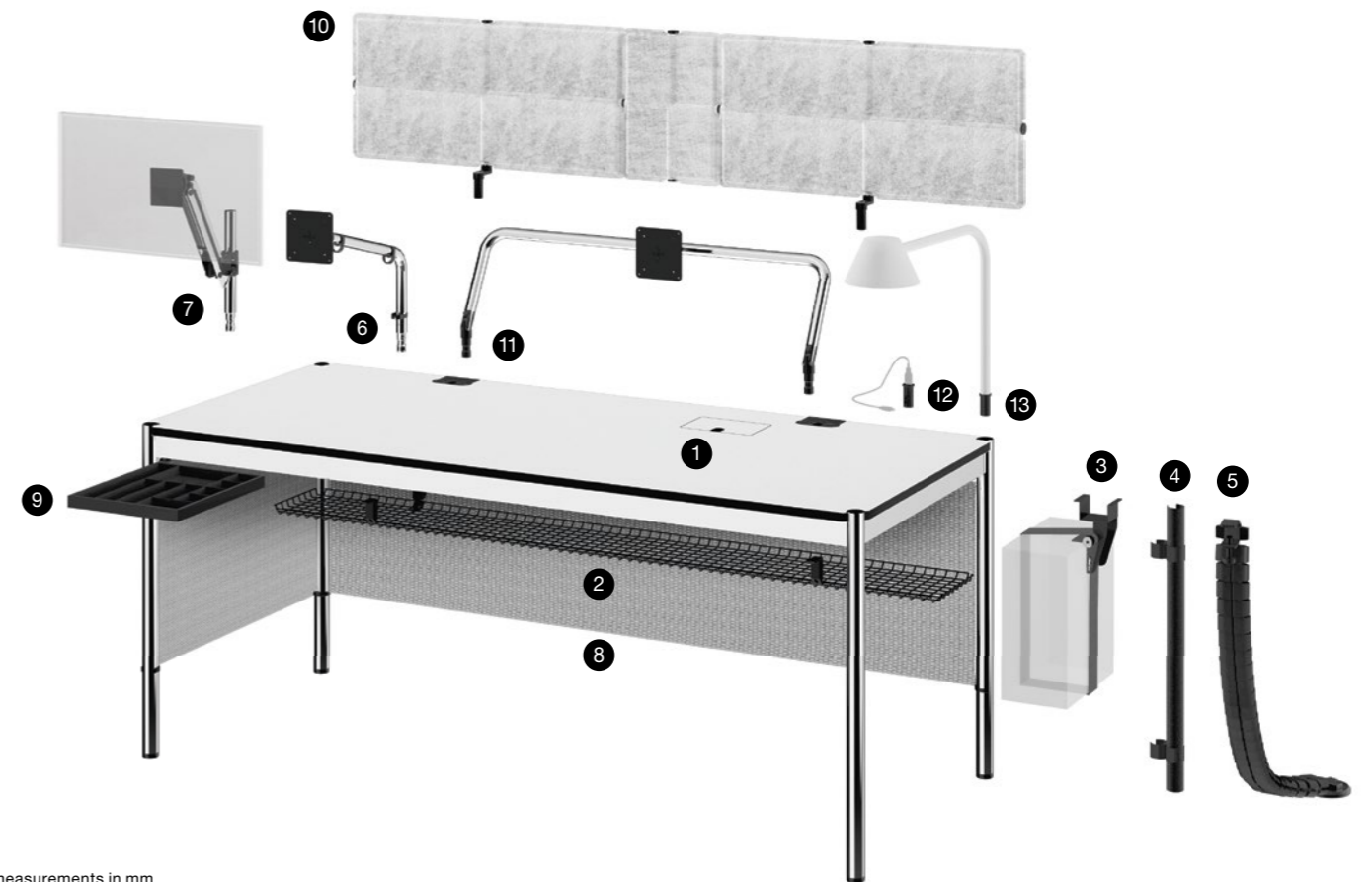

* Only available in the surfaces pearl grey laminate, black linoleum and Fenix, Grigio Londra
All measurements in mm.

All measurements in mm.

Colours & surfaces

USM Haller



Metal



USM Haller and USM Kitos tables



Laminate

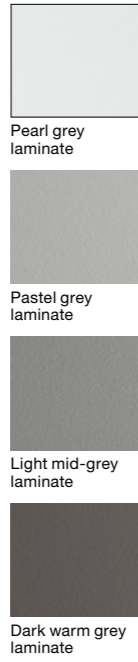

Powder-coated MDF

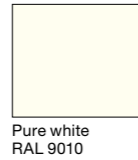

Linoleum

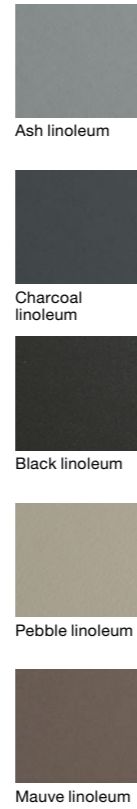

Fenix



Oiled or lacquered veneer

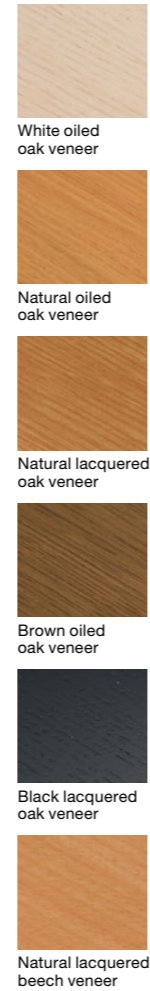

Trans-parent glass

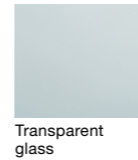

USM Privacy Panels



Fabric panel



USM Inos box



Fabric panel



USM Inos drawer set



Metal



Pots



Clay



Details

USM Haller



Metal

USM Haller table

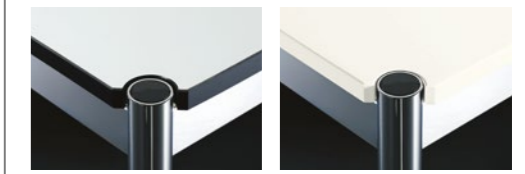

Laminate

Powder-coated MDF

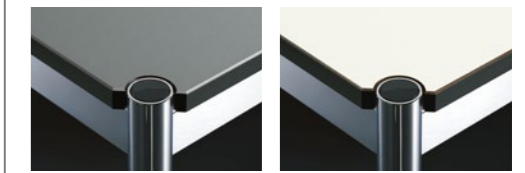

Linoleum

Fenix

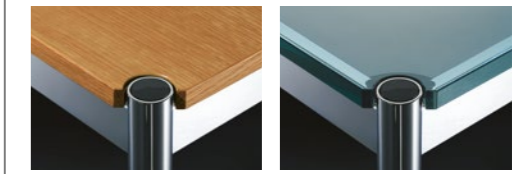

Oiled or lacquered veneer

Transparent glass

USM Kitos table

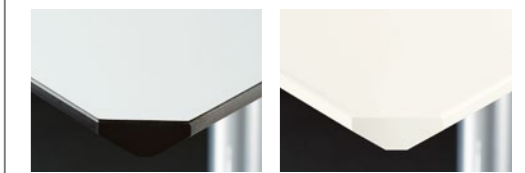

Laminate

Powder-coated MDF

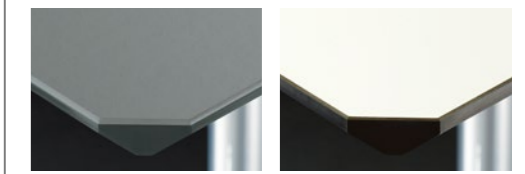

Linoleum

Fenix

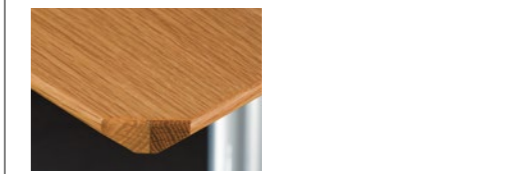

Oiled or lacquered veneer

The tabletop in glass is only available for USM Haller desks up to L: 2000 mm.
Other colours and surfaces available upon request.
Prices and delivery times of table surfaces upon request.

The following options are available
in graphite black and pure white only:
USM Inos drawer set, 5 drawers, open
USM Inos drawer set, 10 drawers, closed
USM Inos drawer set, 10 drawers, open