

Let's work together



Office Tables



“Shared workstation”, “social and collaboration areas” and “hot desking” are terms that reflect current changes in the world of work and that make new demands on the modern working environment.

Whether we work at home or in the office, the technology we use to generate and disseminate knowledge and to network with colleagues is playing an increasingly important role. At the same time, the facilities offered at the workplace are becoming an increasingly important factor in the recruitment and retention of highly qualified employees. Similarly, a high degree of individualisation of the workplace is becoming more and more significant – especially in the multi-generational office.

USM’s wide range of table systems offers solutions that can be adapted to meet the demands of individual users, today and in the future, at home and in the office.



USM Haller



USM Haller Plus



USM Haller Advanced



USM Kitos



USM Kitos E



USM Kitos E Plus



USM Kitos E Meeting



USM Kitos M



USM Kitos M Plus



USM Kitos M Meeting

USM Haller



The extremely sturdy USM Haller tables are built up on the basis of their chrome legs and frames. Their table tops are available in a range of different shapes, sizes and materials to complement the linear design. Their flexible application allows them to be used as a workstation or conference table, forming a perfect combination with other products from the USM modular furniture range. Smart solutions are used to integrate other features into the tables: electric cables are neatly stowed away in a cable trough under the table top and can easily be accessed via flaps, while utility sockets on surface of the table allow ancillary equipment to be easily plugged in.

Clean lines

The USM Haller Table, designed more than 60 years ago, goes well with the other members of the USM Modular Furniture Haller collection thanks to its timeless elegance.

Versatile

Useful accessories extend the table's functionality and make room for a wide range of applications. An optional hinged cover integrated into the tabletop gives easy network access.



USM Haller Table

Designed more than 60 years ago, the USM Haller Table has become a classic of modern design. It harmonizes perfectly with the USM Modular Furniture Haller. Various accessories can be adapted to the table allowing room for further expansion.

Electrification

- Optional cable wire basket; accessible from front or back below table top
- Optional grommet hatch for network access

Dimensions in mm

H: 740

L: 3000 / D: 1000

L: 3000 / D: 750

H: 740 / 370

L: 2500 / D: 1000

L: 2500 / D: 750

L: 2250 / D: 1000

L: 2250 / D: 750

L: 2000 / D: 1000

L: 2000 / D: 750

L: 1750 / D: 1000

L: 1750 / D: 750

L: 1500 / D: 1000

L: 1500 / D: 750

L: 1250 / D: 750

L: 1250 / D: 500 *

L: 1000 / D: 1000

L: 750 / D: 750

* Only available in the surfaces pearl gray laminate, black linoleum and Fenix, Grigio Londra.



USM Haller Table Plus

The USM Haller Table Plus has two removable adaptation points that enable various accessories to be quickly and easily mounted and provide for streamlined cabling. For the Cabling solution, the adaptation points are removed, the cables placed in the guide and the adaptation points reinserted in the tabletop. An additional cable wire basket can be attached under the tabletop that bundles all cables together and conceals them elegantly.

Electrification

- Two removable adaptation points for up to four accessories
- Optional cable wire basket: access from the front or the rear, underneath the tabletop
- Optional grommet hatch for network access

Dimensions in mm

H: 740

L: 3000 / D: 1000

L: 3000 / D: 750

L: 2000 / D: 1000

L: 2000 / D: 750

L: 1750 / D: 1000

L: 1750 / D: 750

L: 1500 / D: 1000

L: 1500 / D: 750

L: 1250 / D: 750



USM Haller Table Advanced

The USM Haller Table Advanced is the most comfortable version for attaching accessories and organizing cable management. In addition to the permanently attached adaptation points, the Advanced version also offers a sliding tabletop. It slides forward to allow access to the cable tray for storage space and cable attachment options. Accessories attached to the adaptation points as well as all objects on the table do not have to be removed to access the cable tray.

Electrification

- Two adaptation points for up to four accessories
- Fixed cable tray; access from above by sliding away the tabletop
- Optional grommet hatch for network access

Dimensions in mm

H: 740

L: 2000 / D: 1000

L: 2000 / D: 750

L: 1750 / D: 1000

L: 1750 / D: 750

L: 1500 / D: 1000

L: 1500 / D: 750

L: 1250 / D: 750



Accessories

USM Haller

1 Universal support

Is mounted on the table frame and serves as a holder for various accessory parts.

2 Flat screen pivot arm

Screens are screwed to the height-adjustable pivot arm using a mounting plate (VESA standard). The flat screen pivot arm can be mounted onto the table frame with the universal support (1). Continuously height-adjustable for screens weighing up to 12 kg.

3 Grommet hatch for network access

Hatch for a single power outlet, flush-mounted in tabletop. This unit can be mounted in two different positions on the tabletop.

4 USM Privacy Panels

Fitted on the long side of the table to provide individualisation and privacy. H: 350 or H: 700. For tables with lengths: 3000, 2500, 2250, 2000, 1750, 1500, 1250, 1000, 750.

5 Cable guide

Is clamped to the table legs and guides cables to their outlets.

6 Link chain

Holds and directs cables to the power source. Flexible and adjustable to various lengths.

7 Front and side panel

Can be attached under the table to the long side or laterally. For tables with lengths: 2000, 1750, 1500, 1250, 1000, 750, and depth: 1000, 750.

8 Cable wire basket

For the cable management a cable wire basket can be used. It is hung under the tabletop, out of sight.

9 Pivoting pen holder

Provides room for writing instruments and can be discreetly stowed under the tabletop.

All measurements in mm.

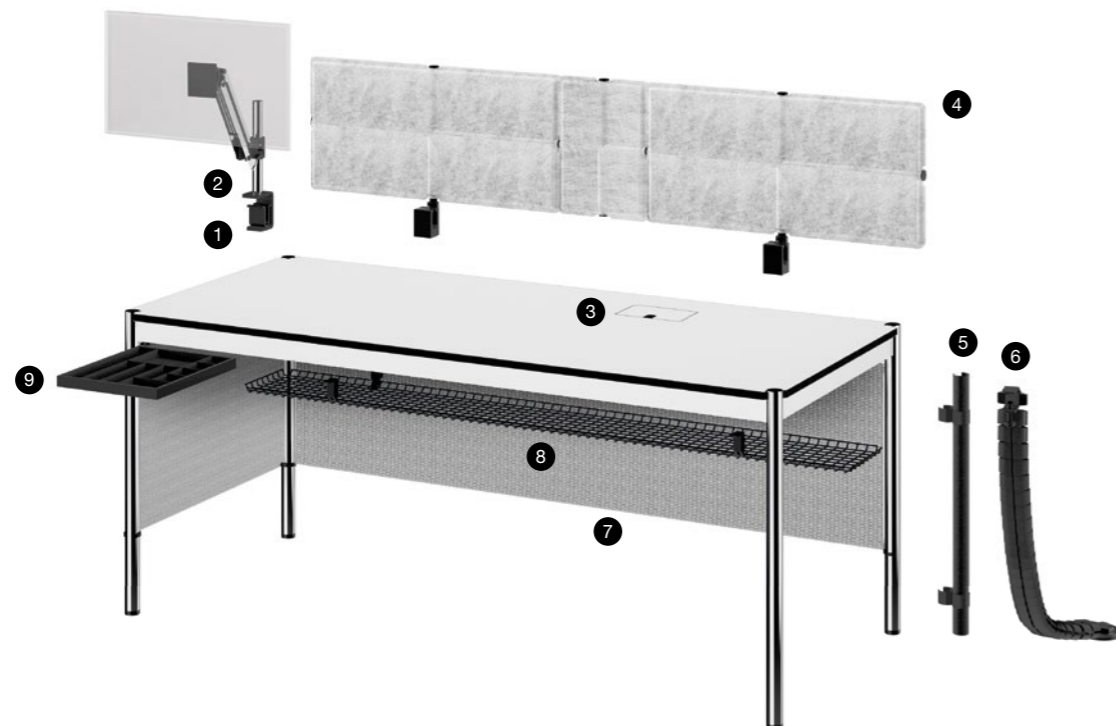

Accessories

USM Haller Plus / Advanced

1 Grommet hatch for network access

Hatch for a single power outlet, flush-mounted in tabletop. This unit can be mounted in two different positions on the tabletop.

2 Cable management

For the USM Haller Advanced table, a cable tray integrated under the tabletop offers storage room and attachment options for all cables and technical components. For the USM Haller Plus table, a cable wire basket can be attached.

3 Cable guide

Is clamped to the table legs and guides cables to their outlets.

4 Link chain

Holds and directs cables to the power source. Flexible and adjustable to various lengths.

5 Flat screen support arm

Screens are mounted onto the support arm (VESA standard), which can be connected directly to one of the adaptation points. Swivel-type with a spherical joint for the screen. Mounting at different heights is possible for screens weighing up to 12 kg.

6 Flat screen pivot arm

Screens are screwed to the height-adjustable pivot arm using a mounting plate (VESA standard). The pivot arm can be inserted into one of the adaptation points with a tube set. Continuous height adjustment for screens weighing up to 12 kg.

7 Front and side panel

Can be attached under the table to the long side or laterally. For tables with lengths: 2000, 1750, 1500, 1250 and depths: 1000, 750.

8 Pivoting pen holder

Provides room for writing instruments and can be discreetly stowed under the tabletop.

9 USM Privacy Panels

Fitted on the long side of the table to provide individualisation and privacy. H: 350 or H: 700. For tables with lengths: 3000, 2000, 1750, 1500.

10 Flat screen support bar

The support bar is inserted into the adaptation points. Up to two screens (max. 2 x 12 kg) can be attached using a mounting plate (VESA standard). Screens can be mounted at different heights; screens can be adjusted with ball joints. Continuously height-adjustable for screens weighing up to 12 kg.

Options:

10a Flat screen support bar fix

10b Flat screen support bar adjustable
Move forwards or backwards two notches at a time to adjust the viewing distance.

11 USB adapter

The adapter can be used for USB A 3.0 and C connections. It can easily be inserted into the adaptation point. Usable as power supply or for data transfer.

12 Lamp peg

An optional lamp peg for easy attachment of selected table lamps. Electrification is possible through the adaptation point.

All measurements in mm.

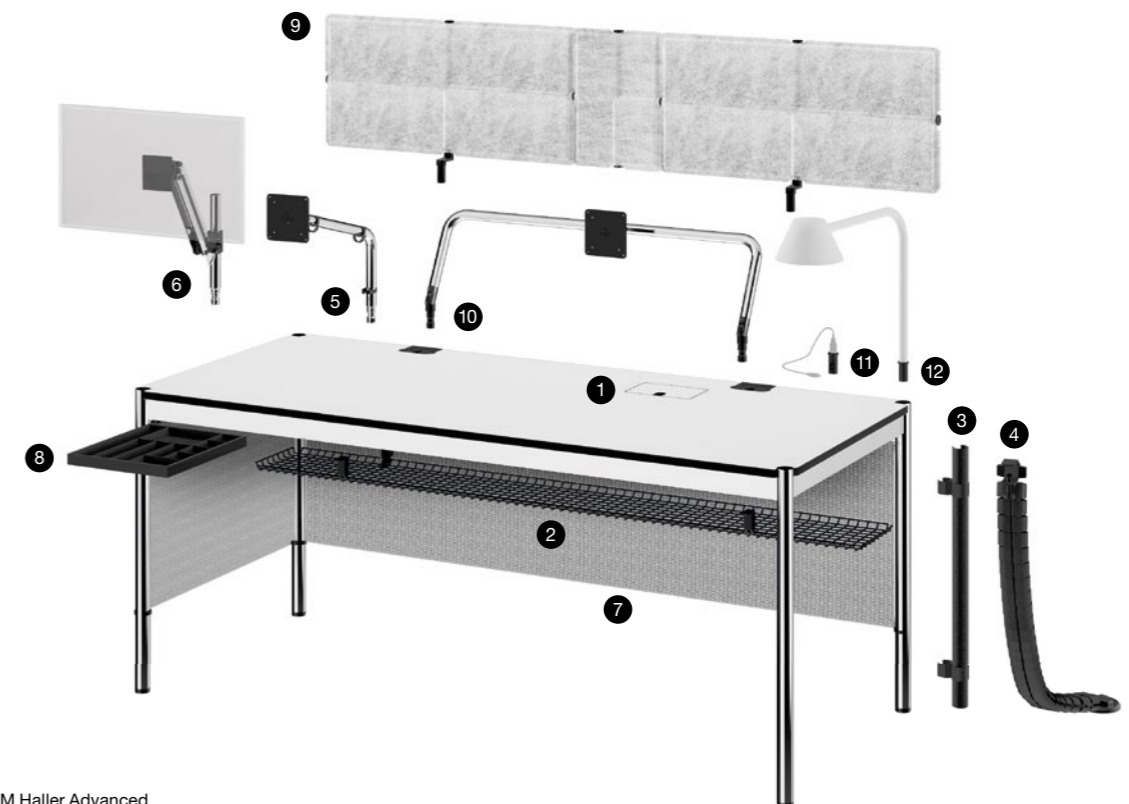

Illustration: USM Haller Advanced

USM Kitos



USM Kitos can be used to create table configurations to match any work style, standing or sitting, in the form of single desks or group workstations. Optional electronic or mechanical height adjustment combined with easy-to-use facilities for incorporating accessories make it possible to meet the individual requirements of each user.

These are the benefits of USM Kitos:

Ergonomic design

The electronic or mechanical height adjustment system used in the USM Kitos E and USM Kitos M permits standing or sitting work, and allows the table to be adapted to the personal requirements of its users. All the features of the USM Kitos E and USM Kitos M make them ideally suited for desk sharing and hot desking.

Stable construction with ample leg room

Its widely spaced feet and sophisticated design give the USM Kitos tables superb sturdiness and stability. Even at its maximum height of 1300mm, the USM Kitos E is extremely stable and meets the requirements on oscillatory behaviour laid down in the relevant standards. Furthermore, it guarantees optimum freedom of movement for the user's legs and knees, in compliance with the relevant standards.

Versatility

The two adaptor points in the tabletop permit easy insertion of up to four accessories, thus making it possible to adapt the table to meet individual user requirements.

Smart electrification

Cable glands permit passage of all electrical leads from the tabletop to the cable tray mounted under it. Depending on the model in question, the tabletop can be tilted or pushed forward for easy access to the cable underneath.

Flexible conference table

The amply dimensioned Kitos Meeting table makes conferencing a pleasure. The extra-long feet under the table – a new feature – ensure optimum leg room for the user and great stability even when the table height is adjusted to the maximum value.

Futureproof

The height adjustment system of all three new USM Kitos M tables is purely mechanical, and thus independent of the power supply. The spring loading of the height adjustment system can be adjusted to match the load on the table, thus minimising the effort required to adjust the height.

USM Kitos E Meeting





USM Kitos M

This version is the ideal solution for users who do not need any accessories but appreciate quick, simple height-adjustment. The retractable cable trough, allowing the necessary cables to be stowed away quickly and simply, is another useful feature.

Electrification

- Access from behind folding down the cable tray
- Optional grommet hatch for network access

Dimensions in mm

L: 1800 / D: 900
L: 1750 / D: 750
L: 1600 / D: 800

Height

M: Height-adjustable, 700–1200

Available with optional height indicator.



USM Kitos M Plus

Apart from the speedy height adjustment offered by the USM Kitos M, this version offers the added convenience of the adaptor points permitting the easy connection of up to four accessories. Cable glands built into the tabletop permit passage of all electrical leads from the tabletop to the cable tray mounted under it. The tabletop can be slid forward for easy access to the cable underneath.

Electrification

- Two adaptation points for up to four accessories
- Cable tray; access from above by sliding the tabletop back
- Optional grommet hatch for network access

Dimensions in mm

L: 1800 / D: 900
L: 1750 / D: 750
L: 1600 / D: 800

Height

M: Height-adjustable, 700–1200

Available with optional height indicator.



USM Kitos M Meeting

Extra large table size combined with mechanical height adjustment create the ideal conditions for conferencing. A cable tray is mounted round the bottom edge of the tabletop, and can be accessed from below or optionally from above via two hatches in the tabletop. USM Kitos M Meeting is the future-proof solution for conferencing – seated or standing.

Electrification

- Cable tray; access from all sides underneath the tabletop
- Optional grommet hatch for network access

Dimensions in mm

L: 2500 / D: 1000
L: 2250 / D: 1000

Height

M: Height-adjustable, 700–1150

Available with optional height indicator.



The height of the USM Kitos M can be set to any desired value within the range 700–1200 mm in a matter of seconds by the manually operated height-adjustment system, to meet the user's individual requirements. The patented mechanism works roughly 10 times faster than an electronic system, requires very little service and has a long life.

USM Kitos E

Whether doing work sitting or standing—the optional height adjustability always offers an optimal ergonomic solution. Even in its full height, the table is extraordinarily stable and easily meets the standards for vibration resistance. And it guarantees the greatest possible amount of leg and knee room. Barely visible, a cable tray is located below the tabletop. It can be accessed from the front underneath the tabletop or optionally from above through a power access flap in the tabletop.

Electrification

- Cable tray; access from behind folding down the cable tray
- Optional grommet hatch for network access

Dimensions in mm

L: 1800 / D: 900 (GS certified)**
L: 1750 / D: 750
L: 1600 / D: 800 (GS certified)**

Height

Kitos E1: 740*
Kitos E2: Height adjustable, 700–1200
Kitos E3: Height adjustable, 650–1300**

* Does not include middle traverse; optionally available with middle traverse when ordering.

** Available in a GS Mark tested version (with 3 mm table edge radius and asymmetric crossbar; only available for E3 in the dimensions L: 1800 / D: 900 and L: 1600 / D: 800).



USM Kitos E Plus

Up to four accessories can easily be inserted into two of the adaptation points set into the tabletop: flat screen support arm, pivot arm or bar, screen panels, adapters for table lamps or USB connections. Integrated cable bushings route all electrical connections from the tabletop into the cable tray underneath the tabletop. For easy access to the cables, the tabletop can be slid forwards.

Electrification

- Two adaptation points for up to four accessories
- Cable tray; access from above by sliding away the tabletop
- Optional grommet hatch for network access

Dimensions in mm

L: 1800 / D: 900
L: 1750 / D: 750
L: 1600 / D: 800

Height

Kitos E1: 740*
Kitos E2: Height adjustable, 700–1200
Kitos E3: Height adjustable, 650–1300

* Does not include middle traverse; optionally available with middle traverse when ordering.



USM Kitos E Meeting

Extra long, wide table size combined with electronic height adjustment gives the ideal conditions for sitting or standing conferencing, backed up by the ergonomic design: the extra-long feet under the table, for maximum leg room, the big cable tray mounted under the middle of the tabletop, accessed from both sides and the two optional grommet hatches for network access that can be recessed into the tabletop.

Electrification

- Cable tray; access from all sides underneath the tabletop
- Two optional grommet hatches for network access

Dimensions in mm

L: 2500 / D: 1250
L: 2500 / D: 1000
L: 2250 / D: 1000

Height

Kitos E1: 740
Kitos E2: Height adjustable, 700–1200
Kitos E3: Height adjustable, 650–1300

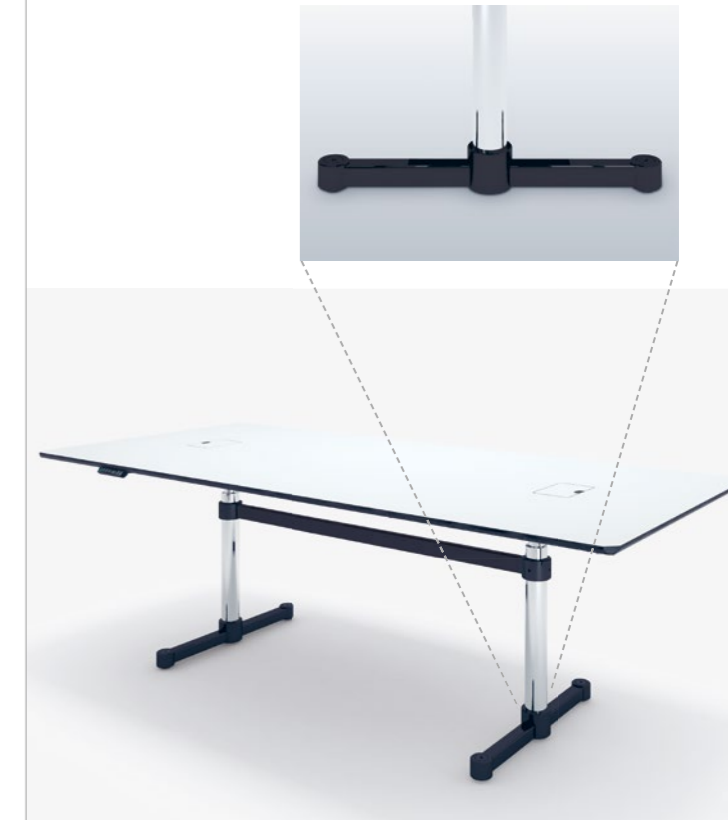

Accessories

USM Kitos M and E

for all USM Kitos M and E Desks

- 1 **Grommet hatch for network access**
Hatch for a single power outlet, flush-mounted in tabletop. This unit can be mounted in two different positions on the tabletop.
- 2 **Link chain**
Holds and directs cables to the power source. Flexible and adjustable to various lengths.
- 3 **USM Privacy Panels**
Fitted on the long side of the table to provide individualisation and privacy. H: 350 or 700. For tables with lengths: 2500, 2250, 1800, 1750, 1600.

for all USM Kitos M and E Desks, except USM Kitos M Meeting / E Meeting

- 4 **Flat screen pivot arm**
Screens are screwed to the height adjustable pivot arm using a mounting plate (VESA standard). Available for USM Kitos E and M tables: the pivot arm is mounted onto the tabletop using the universal support. Available for USM Kitos M and E Plus: The pivot arm can be inserted into one of the adaptation points with a tube set. Continuous height adjustment for screens weighing up to 12 kg.
- 5 **Front panel**
Can be attached under the table to the long side or laterally. For tables with lengths: 1800, 1750, 1600.
- 6 **Material tray**
Provides room for writing instruments and can be discreetly stowed under the tabletop.

for USM Kitos M Plus / E Plus

- 7 **Flat screen support arm**
Screens are mounted onto the support arm (VESA standard) which can be connected directly to one of the adaptation points. Swivel-type with a spherical joint for the screen. Mounting at different heights is possible for screens weighing up to 12 kg.
- 8 **Flat screen support bar**
The bracket is inserted into the adaptation points. Up to two screens (max. 2 x 12 kg) can be attached using a mounting plate (VESA standard). Screens can be mounted at different heights; screens can be adjusted with ball joints.
- Options:
 - 8a **Flat screen support bar fix**
 - 8b **Flat screen support bar adjustable**
Move forwards or backwards two notches at a time to adjust the viewing distance.
- 9 **USB adapter**
The adapter can be used for USB A 3.0 and C connections. It can easily be inserted into the adaptation point. Usable as power supply or for data transfer.
- 10 **Lamp peg**
An optional lamp peg for easy attachment of selected table lamps. Electrification is possible through the adaptation point.

All measurements in mm.



Illustration: USM Kitos M Plus

Small tables are the ideal meeting place for short talks in social and collaboration areas away from one's regular worksite.

Square or round free-standing USM Kitos tables with an energy-saving height-adjustment system are the ideal venue for colleagues to stand around for a brief conversation and the next moment can be transformed into a work table where temporary staff can sit.

These free-standing tables also offer useful extra space in a larger office.



USM Kitos E Free-standing

- 

Height: 740 mm
L: 750 / D: 750 mm
L: 900 / D: 900 mm
- 

Height: 700–1110 mm
L: 750 / D: 750 mm
L: 900 / D: 900 mm
- 

Height: 740 mm
ø 900 mm
ø 1100 mm
- 

Height: 700–1110 mm
ø 900 mm
ø 1100 mm



USM Kitos

The Kitos Table is extremely stable, even at maximum height. The attractive design can be complemented with a wide range of functionality through the incorporation of practical accessories.

Electrification

– Optional cable wire basket, accessed from below

Dimensions in mm

L: 1800 / D: 900
 L: 1750 / D: 750
 L: 1500 / D: 750
 L: 900 / D: 750

Continuous height adjustment H: 700 – 1200

USM Kitos is a table system that meets all requirements made of a modern worksite, from a simple conference table to a complete workstation.



Accessories

USM Kitos

1 Universal support

Is mounted directly onto the tabletop to hold various accessories.

2 Flat screen pivot arm

Screens are screwed to the height-adjustable pivot arm using a mounting plate (VESA standard). The pivot arm can be mounted onto the tabletop using the universal support (1). Continuously height-adjustable for screens weighing up to 12 kg.

3 USM Privacy Panels

Fitted on the long side of the table to provide individualisation and privacy. H: 350 or H: 700. For tables with lengths: 1800, 1750, 1500.

4 Link chain

Holds and directs cables to the power source. Flexible and adjustable to various lengths.

5 Cable wire basket

For the cable management a cable wire basket can be used. It is hung under the tabletop out of sight.









6 Material tray

Provides room for writing instruments and can be discreetly stowed under the tabletop.

All measurements in mm.

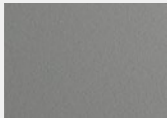
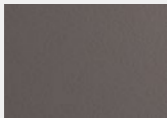
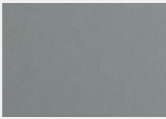
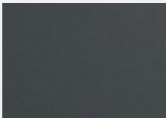
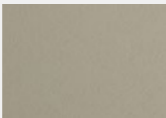
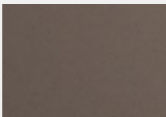
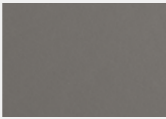

Colors & surfaces

	Price category 1	Price category 2			
	<p>Laminate</p> <p>Laminate surfaces are composed of a synthetic resin and are highly durable, as they are extremely resistant to wear, denting and scratching. A thin, black resin strip borders the table.</p>	<p>Powdercoated MDF</p> <p>Composed of natural wood materials, the medium-density fiberboard (MDF) is finished with a thin powder coating for an overall protective seal. The result is a durable, scratch and impact resistant tabletop.</p>	<p>Linoleum</p> <p>Linoleum has a leather-like quality created from an inlay of natural components and sustainable materials, including linseed oil and wood. It is also slightly elastic and has antistatic properties that help keep dust from settling on its surface.</p>	<p>Fenix</p> <p>Fenix consists of an extremely fine-pored coat of clear varnish. This nano paint is resistant to knocks, scratches, friction, acids and dirt. It is also known for its anti-fingerprint properties, as grease is virtually incapable of infiltrating the structure of the finish. Fenix feels soft and has a very matt gloss level.</p>	<p>Lacquered wood veneer</p> <p>A water-based lacquer gives this surface finish a slight gloss, and enhances the veneer's resistance to various agents. This finish is mainly intended for office use.</p>
delivery category: A	 <p>Pearl gray laminate</p>	 <p>Pure white RAL 9010</p>	 <p>Black linoleum</p>	 <p>Nero Ingo</p>  <p>Bianco Kos</p>	 <p>Black lacquered oak veneer</p>
delivery category: B	 <p>Pastel gray laminate</p>  <p>Light mid-gray laminate</p>  <p>Dark warm gray laminate</p>		 <p>Ash linoleum</p>  <p>Charcoal linoleum</p>  <p>Pebble linoleum</p>  <p>Mauve linoleum</p>	 <p>Grigio Londra</p>	 <p>Natural lacquered oak veneer</p>



Switzerland

USM U. Schärer Söhne AG
Thunstrasse 55, 3110 Münsingen
Phone +41 31 720 72 72, info.ch@usm.com

Germany

USM U. Schärer Söhne GmbH
Siemensstrasse 4a, 77815 Bühl
Phone +49 7223 80 94 0, info.de@usm.com

France

USM U. Schaerer Fils SA, Paris Showroom
23, rue de Bourgogne, 75007 Paris
Phone +33 1 53 59 30 37, info.fr@usm.com

United Kingdom

USM U. Schaerer Sons Ltd., London Showroom
Marylebone Square, 12 Cramer Street
London W1U 4EA
Phone +44 207 183 3470, info.uk@usm.com

USA

USM U. Schaerer Sons Inc., New York Showroom
28–30 Greene Street, New York, NY 10013
Phone +1 212 371 1230, info.us@usm.com

Japan

USM U. Schaerer Sons K.K., Tokyo Showroom
Meiji Yasuda Seimei Building 1-2F
2-1-1 Marunouchi, Chiyoda-ku, Tokyo 100-0005
Phone +81 3 6635 9420, info.jp@usm.com

China

USM Trading (Shanghai) Co. Ltd., Shanghai Showroom
Building C, 2F, Room 201, No. 12 Yongyuan Road
Jing'an District, Shanghai 200040
Phone +86 189 3977 2732, info.cn@usm.com

All other countries
contact USM Switzerland.

usm.com